



100/PT62251(PL)5

DRAFT TECHNICAL REPORT

Project number IEC 62251	
IEC/TC or SC TC 100	Secretariat Netherlands
Distributed on	Voting terminates on
Also of interest to the following committees	Supersedes document
Functions concerned	
<input type="checkbox"/> Safety	<input type="checkbox"/> EMC
<input type="checkbox"/> Environment	<input checked="" type="checkbox"/> Quality assurance

THIS DOCUMENT IS STILL UNDER STUDY AND SUBJECT TO CHANGE. IT SHOULD NOT BE USED FOR REFERENCE PURPOSES.

RECIPIENTS OF THIS DOCUMENT ARE INVITED TO SUBMIT, WITH THEIR COMMENTS, NOTIFICATION OF ANY RELEVANT PATENT RIGHTS OF WHICH THEY ARE AWARE AND TO PROVIDE SUPPORTING DOCUMENTATION.

Title

Multimedia systems and equipment - Quality assessment - Audio-video communication systems

Introduction

This is an internal working document for use only within IEC TC 100/PT 62251. It was revised from 100/PT62251(PL)3A after discussion in ITU-R WP6Q meeting in September 2001 in Geneva and PT62251 meeting in October 2001 in Firenze. Further revised version will be prepared, if necessary, for submission to the Secretariat IEC TC 100.

The members of IEC TC 100/PT 62251 are kindly requested to comment on this document to improve the contents **by the end of January 2002** using the common mailing list or directly to Project Leader for PT62251.

Hiroaki Ikeda
Project leader for PT62251
ikeda@hike.tu.chiba-u.ac.jp

CONTENTS

	Page
1 Scope	4
2 References.....	4
3 Terms and definitions	5
4 Configuration for quality assessment.....	5
4.1 Input and output channels.....	5
4.2 Points of input and output terminals	6
5 Video quality	7
5.1 Introduction	7
5.2 End-to-end tone reproduction.....	8
5.2.1 Item to be assessed	8
5.2.2 Method of assessment	8
5.2.3 Presentation of assessment result.....	8
5.3 End-to-end colour reproduction	10
5.3.1 Item to be assessed	10
5.3.2 Method of assessment	10
5.3.3 Presentation of assessment result.....	10
5.4 End-to-end objective assessment of video quality using the colour difference	11
5.4.1 Item to be assessed	11
5.4.2 Method of assessment	11
5.4.3 Presentation of assessment results	12
5.5 End-to-end objective assessment of video quality in wavelet transformed domain	14
5.5.1 Item to be assessed	14
5.5.2 Method of assessment	15
5.5.3 Presentation of assessment results	15
5.6 End-to-end objective assessment of video quality using the Peak-signal to noise ratio (PSNR).....	18
5.6.1 Item to be assessed	18
5.6.2 Method of assessment	18
5.6.3 Presentation of assessment results	19
6 Audio quality	23
6.1 Perceived audio quality with full-reference signals.....	23
6.1.1 Item to be assessed	23
6.1.2 Justification	23
6.1.3 Method of assessment and algorithm of PEAQ.....	23
6.1.4 Presentation of assessment results	24
6.2 Sampling rate and quantization resolution	25
6.2.1 Item to be assessed	25
6.2.2 Method of assessment	25
6.2.3 Presentation of assessment results	25
6.3 Delay	25
6.3.1 Item to be assessed	25
6.3.2 Method of assessment	26
6.3.3 Presentation of assessment result.....	26
7 Total quality	26

7.1	Synchronization of audio and video (lip sync)	26
7.1.1	Item to be assessed	26
7.1.2	Method of assessment	26
7.1.3	Presentation of assessment results	27
7.2	Scalability.....	27
7.2.1	Item to be assessed	27
7.2.2	Method of assessment	27
7.2.3	Presentation of assessment results	27
7.3	Overall quality	27
7.3.1	Item to be assessed	27
7.3.2	Method of assessment	27
7.3.3	Presentation of assessment results	28
A.1	Introduction	29
A.2	Test sources and hypothetical deterioration.....	29
Annex B (informative)	PEAQ objective measurement method outline.....	33
B.1	Basic concept of the PEAQ measurement algorithm	33
B.2	Basic version.....	34
B.3	Advanced version	35
B.4	Output value of PEAQ method	36
B.5	Performance of PEAQ measurement method.....	36
	Bibliography	37

INTERNATIONAL ELECTROTECHNICAL COMMISSION

**MULTIMEDIA SYSTEMS AND EQUIPMENT – QUALITY ASSESSMENT –
AUDIO-VIDEO COMMUNICATION SYSTEMS**

FOREWORD

- 1) The IEC (International Electrotechnical Commission) is a worldwide organization for standardization comprising all national electrotechnical committees (IEC National Committees). The object of the IEC is to promote international co-operation on all questions concerning standardization in the electrical and electronic fields. To this end and in addition to other activities, the IEC publishes International Standards. Their preparation is entrusted to technical committees; any IEC National Committee interested in the subject dealt with may participate in this preparatory work. International, governmental and non-governmental organizations liaising with the IEC also participate in this preparation. The IEC collaborates closely with the International Organization for Standardization (ISO) in accordance with conditions determined by agreement between the two organizations.
- 2) The formal decisions or agreements of the IEC on technical matters express, as nearly as possible, an international consensus of opinion on the relevant subjects since each technical committee has representation from all interested National Committees.
- 3) The documents produced have the form of recommendations for international use and are published in the form of standards, technical specifications, technical reports or guides and they are accepted by the National Committees in that sense.
- 4) In order to promote international unification, IEC National Committees undertake to apply IEC International Standards transparently to the maximum extent possible in their national and regional standards. Any divergence between the IEC Standard and the corresponding national or regional standard shall be clearly indicated in the latter.
- 5) The IEC provides no marking procedure to indicate its approval and cannot be rendered responsible for any equipment declared to be in conformity with one of its standards.
- 6) Attention is drawn to the possibility that some of the elements of this technical report may be the subject of patent rights. The IEC shall not be held responsible for identifying any or all such patent rights.

The main task of IEC technical committees is to prepare International Standards. However, a technical committee may propose the publication of a technical report when it has collected data of a different kind from that which is normally published as an International Standard, for example "state of the art".

Technical reports do not necessarily have to be reviewed until the data they provide are considered to be no longer valid or useful by the maintenance team.

IEC 62251, which is a technical report, has been prepared by IEC technical committee 100: Audio, Video and Multimedia Systems and Equipment.

The text of this technical report is based on the following documents:

Enquiry draft	Report on voting
XX/XX/DTR	XX/XX/RVC

Full information on the voting for the approval of this technical report can be found in the report on voting indicated in the above table.

This publication has been drafted in accordance with the ISO/IEC Directives, Part 2.

This document which is purely informative is not to be regarded as an International Standard.

MULTIMEDIA SYSTEMS AND EQUIPMENT – QUALITY ASSESSMENT – AUDIO-VIDEO COMMUNICATION SYSTEMS

1 Scope

This Technical Report specifies items to be measured by objective methods, methods of measurement together with measuring conditions, processing of the measured data and presentation of acquired information for objective assessment of end-to-end quality of audio-video communication systems over digital networks. The measurements are supposed to be conducted in a double-ended and a full reference. The systems are assumed to have electrical interface channels at the input and at the output of audio-video signals for objective assessment.

The extension for systems that do not have such channels is left for further study.

2 References

The following normative documents contain provisions which, through reference in this text, constitute provisions of this International Standard. For dated references, subsequent amendments to, or revisions of, any of these publications do not apply. However, parties to agreements based on this International Standard are encouraged to investigate the possibility of applying the most recent editions of the normative documents indicated below. For undated references, the latest edition of the normative document referred to applies. Members of IEC and ISO maintain registers of currently valid International Standards.

IEC 61146-1: 1994, Video cameras (PAL/SECAM/NTSC) – Methods of measurement – Part 1: Non-broadcast single-sensor cameras.

IEC 61146-2: 1997, Video cameras (PAL/SECAM/NTSC) – Methods of measurement – Part 2: Two- and three-sensor professional cameras.

IEC 61966-9: 2000, Multimedia systems and equipment – Colour measurement and management – Part 9: Digital cameras.

IEC 60268-4, Sound system equipment – Part 4: Microphones.

IEC 60268-5, Sound system equipment – Part 5: Loudspeakers.

IEC 61966-2-1: 1999, Multimedia systems and equipment – Colour measurement and management – Part 1: Colour management – Default RGB colour space – sRGB.

IEC 61966-2-1 Amendment 1: ---1), Multimedia systems and equipment – Colour measurement and management – Part 2-1 Amendment 1: Colour management – Default RGB colour space – sRGB.

IEC 61966-3: 2000, Multimedia systems and equipment – Colour measurement and management – Part 3: Equipment using cathode ray tubes.

IEC 61966-4: 2000, Multimedia systems and equipment – Colour measurement and management – Part 4: Equipment using liquid crystal display panels.

IEC 61966-5: 2000, Multimedia systems and equipment – Colour measurement and management – Part 5: Equipment using plasma display panels.

Publication CIE 15.2: 1986, Colorimetry.

Recommendation ITU-R BT.601-5 (10/95), Studio encoding parameters of digital television for standard 4:3 and wide-screen 16:9 aspect ratios

Recommendation ITU-T J.144 (03/01), Objective perceptual video quality measurement techniques for digital cable television in the presence of a full reference.

1) Under development by TC 100/TA 2.

Revision to Recommendation ITU-R BS.1387 (11/01), Method for objective measurements of perceived audio quality.

Recommendation ITU-T P.931 (12/98), Multimedia communications delays, synchronization and frame rate measurement.

3 Terms and definitions

To understand this Technical Report, following terms and definitions apply.

3.1

audio-video communication system

a system that handles audio, video and optionally other data streams in a synchronized way within users' perception in order to transmit and/or exchange information, which is assumed to operate over a local- or wide-area digital network

3.2

DMOS

difference between the source and processed Mean Opinion Scores (MOS) resulting from the subjective testing experiment conducted by the Video Quality Expert Group (VQEG)

3.3

VQR

objective video quality rating reduced from any objective metric by optimally correlated with the DMOS

3.4

PSNR

objective video quality metric defined by peak-signal to noise ratio, where the noise being calculated from the source and processed video frames

3.5

PEAQ

perceived evaluation of audio quality defined by ITU-R BS.1387

4 Configuration for quality assessment

4.1 Input and output channels

Audio signal and video signal in audio-video streams shall be captured at the input and at the output channel, respectively, of the audio-video communication system as shown in figure 1.

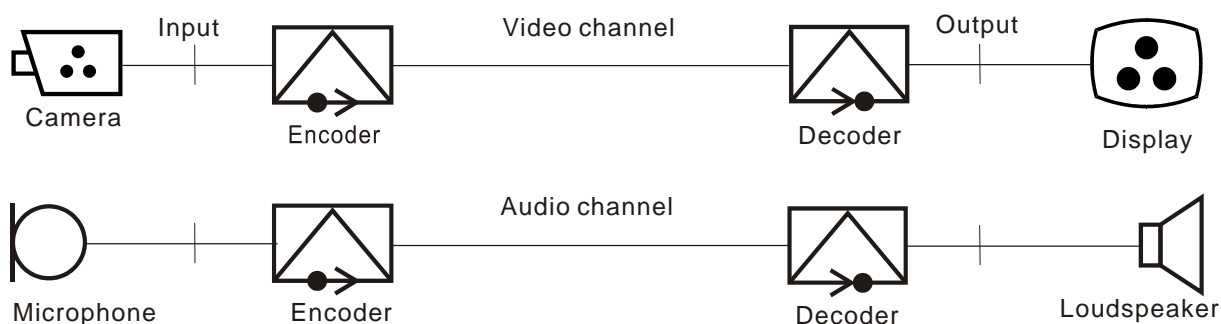
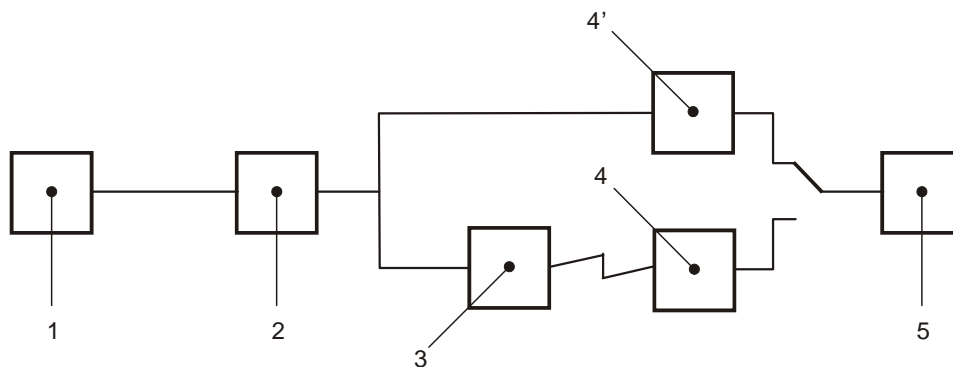

Figure 1 – Model of audio-video communication systems

4.2 Points of input and output terminals

In the spirit of the end-to-end quality assessment of audio-video communication systems, the points for acquisition of raw data should be as far as ultimate end points as possible. However, since the methods of measurement and characterisation for equipment which incorporates input transducers such as video cameras and microphones have already been standardised, such as in IEC 61146-1, IEC 61146-2, IEC 61966-9 and IEC 60268-4, and the methods of measurement and characterisation of equipment which incorporates output transducers such as video signal displays and loudspeakers, such as in IEC 61966-3, IEC 61966-4, IEC 61966-5 and IEC 60268-5, they can be outside of the scope of the range of the end-to-end.

Figure 2 shows a schematic diagram for quality assessment under double-ended and full reference conditions.



Key

- 1 Original audio or video reference.
- 2 Pre-conditioner: Reduced dynamic range, frequency range for audio; reduced frame size and frame rate for video to fit to the quality assessment of the audio-video communication systems, if necessary.
- 3 Encoder for network streaming with a specified bit-rate in order to fit to the bandwidth of end-to-end network connection.
- 4 Decoder and rendering for the received data to make them audible and visible.
- 4' Rendering for the preconditioned data to make them audible and visible, optional.
- 5 Data acquisition and calculation for quality assessment to provide information specified in this report.

Figure 2 – Schematic diagram for quality assessment

5 Video quality

5.1 Introduction

For the purpose of end-to-end objective assessment of video quality, two aspects have been covered in this Technical Report; one is static characteristics such as tone reproduction and colour reproduction described in 5.2 and 5.3, the other dynamic characteristics based on streaming of video frames to networks described in 5.4, 5.5 and 5.6.

It is recommended to make use of the commonly available video source as references such as the test sequences in the Canadian Research Centre (CRC) as the original video reference for the item 1 in figure 2. Because of its high bit-rate and large frame size, the reference source should be reduced in frame size and bit-rate for use as the item 2 in figure 2, if necessary, for actual encoding as streaming video to a network with limited bandwidth.

For the dynamic characteristics, reference video sequences listed in table 1 are available.

Table 1 – Reference sources used in objective assessment

Designation	Name	Contents
SRC13_REF__525	Balloon-pops	film, saturated colour, movement
SRC14_REF__525	New York 2	masking effect, movement
SRC15_REF__525	Mobile & Calendar	colour, movement
SRC16_REF__525	Betes_pas_betes	colour, synthetic, movement, scene cut
SRC17_REF__525	Le_point	colour, transparency, movement in all the directions
SRC18_REF__525	Autumn leaves	colour, landscape, zooming, water fall movement
SRC19_REF__525	Football	colour, movement
SRC20_REF__525	Sailboat	almost still
SRC21_REF__525	Susie	skin color
SRC22_REF__525	Tempete	colour, movement

All reference video sources in table 1 have been adopted in this Technical Report with the permission of the owner, the Canadian Research Council (CRC), which were used by the Video Quality Expert Group (VQEG) for subject video quality tests to obtain the difference of mean opinion score (DMOS) and also object video quality metric (VQR) as reported in ITU-R 10-11Q/56-E.

The format of each of the reference video sources is composed of 10 frames (for leader) + Video for eight seconds + 10 frames (for trailer).

There are two video formats 525@60Hz and 625@50Hz, but only 525@60Hz format is adopted in this Technical Report.

Each line is in pixel multiplexed 4:2:2 component video format as Cb Y Cr Y ... and so on, encoded in line with ITU-R BT.601-5, where 720 bytes/line for Y, 360 bytes/line for Cb and 360 bytes/line for Cr. The lines are concatenated into frames and frames are concatenated to form the sequence files.

The format contains 720 pixels (1 440 bytes) per horizontal line and has 486 active lines per frame. The frame sizes are $1\ 440 \times 486 = 699\ 840$ bytes/frame and the sequence sizes are
4WD 2002-01-07

240 frames file size for 8 s + 20 frames file size = 699 840 bytes/frame x 260 frames = 181 958 400 bytes. 30 frame/s will result a bit-rate of 699 840 bytes/frame x 30 frame/s x 8 = 167 961 600 bit/s. Since it is too high bit-rate to be handled by ordinary personal computers and to be streamed to the Internet, the original test sequences have been reduced in frame size to be 320 x 240 pixels, and in format to be RGB (instead of YCC) 24-bit/pixel to fit to a typical video format (AVI).

NOTE 1 – Pixel-by-pixel error assessment requires a very high degree of normalisation to be used with confidence. The normalisation requires both spatial and temporal alignment as well as corrections for gain and offset. For this purpose, A2 of ITU-R 6Q/39-E should be referred to.

NOTE 2 – Since the values of objective quality metrics largely depend on video contents, varieties of commonly available video sources should be used as far as possible.

NOTE 3 – Video quality metrics obtained by objective assessment in Clause 5 should be converted to be VQR by optimum correlation with DMOS, which is left for further studies in ITU-R WP 6Q.

5.2 End-to-end tone reproduction

5.2.1 Item to be assessed

End-to-end non-linearity in term of tone reproduction.

5.2.2 Method of assessment

An image of the grey steps chart defined in IEC 61146-1, as shown in figure 3, should be used as the reference source at the item 1 in figure 2. The still neutral image should be prepared as a file for the item 2 in figure 2 and repeatedly encoded to be a streaming video transmitted to a network.

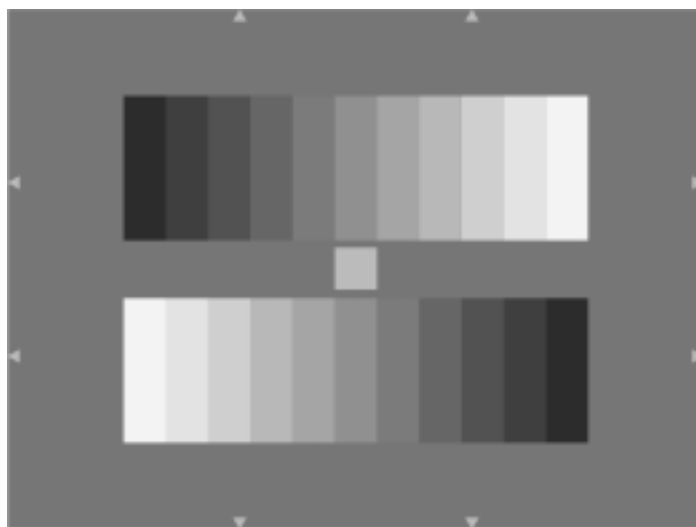

Figure 3 – The image of the grey steps defined in IEC 61146-1

Received streaming video should be decoded and rendered by a viewer for the incoming streaming videos. An image data to be displayed should be captured at an output terminal.

The image data should be compared in terms of three component data, R, G and B averaged in each of the corresponding areas.

5.2.3 Presentation of assessment result

The data for display versus the input image data should be reported as a table and a plot as shown in table 2 and figure 4, respectively, as examples, together with the audio-video communication system under assessment and the specification of the input-output point.

Table 2 – An example of tone reproduction

	Specification			Input			Output		
	R %	G %	B %	R	G	B	R	G	B
0	2,0	2,0	2,0	44	43	44	34	39	28
1	4,5	4,5	4,5	63	63	62	55	60	53
2	8,1	8,1	8,1	82	81	82	73	78	69
3	13,0	13,0	13,0	102	102	101	93	98	87
4	19,8	19,8	19,8	123	122	123	115	120	110
5	27,9	27,9	27,9	144	144	144	136	140	128
6	37,8	37,8	37,8	165	164	165	158	163	152
7	48,6	48,6	48,6	184	184	186	174	180	171
8	63,0	63,0	63,0	207	206	208	198	203	195
9	77,3	77,3	77,3	226	227	228	216	219	213
10	89,9	89,9	89,9	243	243	235	217	218	211

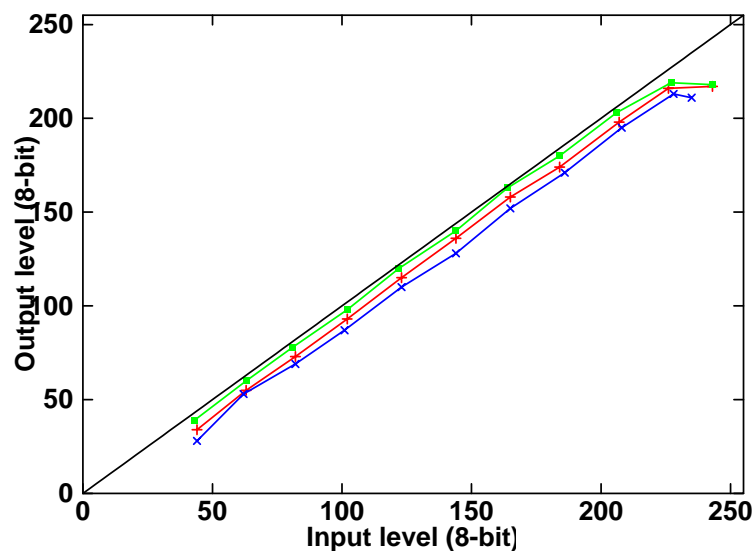

Figure 4 – An example plot of tone reproduction

5.3 End-to-end colour reproduction

5.3.1 Item to be assessed

End-to-end colour shifts in the CIELAB colour space for static colour image.

5.3.2 Method of assessment

An image of the colour reproduction chart defined in IEC 61146-1, as shown in figure 5, should be used as the reference source at the item 1 in figure 2. The still colour image should be prepared as a file for the item 2 in figure 2 and repeatedly encoded to be a streaming video transmitted to a network.



Figure 5 – The image of the colour reproduction chart defined in IEC 61146-1

Received streaming video should be decoded and rendered by a viewer for streaming videos. A colour image data to be displayed should be captured at an output terminal.

The image data should be acquired in terms of three component data, R, G and B averaged in each of the corresponding areas.

5.3.3 Presentation of assessment result

Input colours and output colours in R, G and B data should be regarded to be in sRGB defined in IEC 61966-2-1. They should be converted to CIE 1976 L*a*b* uniform colour space. Colour differences ΔE_{ab}^* between the reference data and the received data should be calculated and reported as shown in table 3 as an example.

Table 3 – An example of colour reproduction

	Specification			Input (8-bit x 3)			Output (8-bit x 3)			Colour difference ΔE_{ab}^*
	R %	G %	B %	R	G	B	R	G	B	
0	87,053	80,546	87,216	222	205	222	221	211	215	3,532
1	48,904	24,181	23,419	184	134	132	186	135	129	1,384
2	37,405	27,352	12,466	163	141	99	164	144	91	4,188
3	25,874	32,782	5,646	138	154	69	139	156	66	2,032
4	12,176	34,717	19,279	98	158	121	96	158	123	0,869
5	15,414	34,081	41,443	109	156	171	109	158	166	2,196
6	17,982	29,222	61,449	117	146	204	119	145	196	1,898
7	36,893	24,007	52,231	164	130	190	163	137	187	3,885
8	51,332	22,896	45,507	188	130	178	187	132	162	5,346
9	43,311	3,062	4,885	174	52	65	172	56	54	8,125
10	83,988	56,759	4,964	236	197	65	219	201	62	4,700
11	2,426	25,943	13,965	47	138	104	45	140	105	1,182
12	3,259	7,178	18,424	54	77	118	50	77	113	2,654
13	82,033	49,052	37,190	233	184	163	219	186	157	3,736
14	10,356	12,908	4,612	91	101	63	89	100	53	5,217

$$\overline{\Delta E_{ab}^*} = 3,396$$

5.4 End-to-end objective assessment of video quality using the colour difference

5.4.1 Item to be assessed

The average of colour differences in the psychophysically uniform colour space defined in CIE 15.2 between the reference video frame and the corresponding deteriorated video frame.

5.4.2 Method of assessment

Reference videos in table 1 are used as the item 1 of figure 2. Frame size reduced videos in uncompressed AVI-format should be prepared for the item 2 of figure 2. It is necessary to embed frame numbers at this point so that they can be used to identify received frames corresponding to the transmitted frames.

Encoded and transmitted streaming videos shall be continuously captured. Pixel-by-pixel calculations should be conducted.

The average colour difference $\overline{\Delta E_{ab_k}^*}$ in the psychophysically uniform colour space between the reference and the deteriorated frames k is defined as in equation (1).

$$\overline{\Delta E_{ab_k}^*} = \frac{1}{K} \sum_{m=M_1}^{M_2} \sum_{n=N_1}^{N_2} \sqrt{(L_{d_k}^* - L_{o_k}^*)^2 + (a_{d_k}^* - a_{o_k}^*)^2 + (b_{d_k}^* - b_{o_k}^*)^2} \quad (1)$$

where $K = \frac{1}{(M_2 - M_1 + 1)(N_2 - N_1 + 1)}$; $L_{o_k}^*$, $a_{o_k}^*$ and $b_{o_k}^*$ are the triplet in the CIELAB colour space corresponding to each pixel of the reference video frame k ; $L_{d_k}^*$, $a_{d_k}^*$ and $b_{d_k}^*$ are the

triplet in the CIELAB colour space corresponding to each pixel of the deteriorated video frame k .

The triplets in CIELAB colour space should be deduced from the pixel values R , G and B of the reference and the deteriorated video frames in the default RGB colour space (sRGB) defined in IEC 61966-2-1. Each pixel is positioned at row m and column n in a video frame.

5.4.3 Presentation of assessment results

The colour difference between each of the corresponding frames should be plotted versus frame numbers as shown in figure 6 together with identifications of reference video sources. The conditions of measurement such as frame size in pixels, frame rate, streaming bit-rate should also be reported.

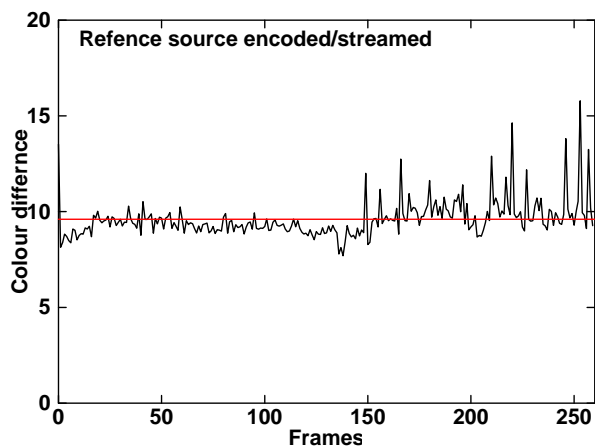

Figure 6a – Example for SRC13_REF__525

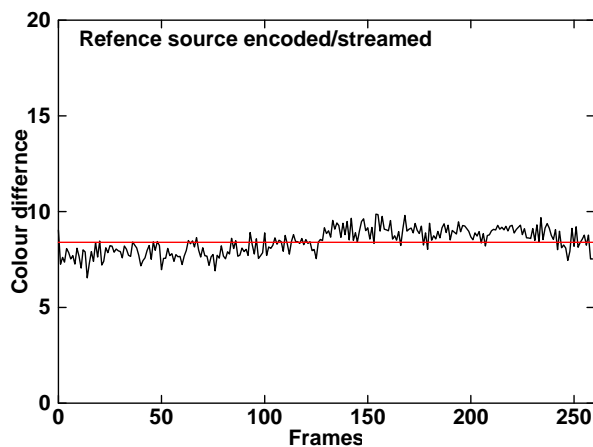

Figure 6b – Example for SRC14_REF__525

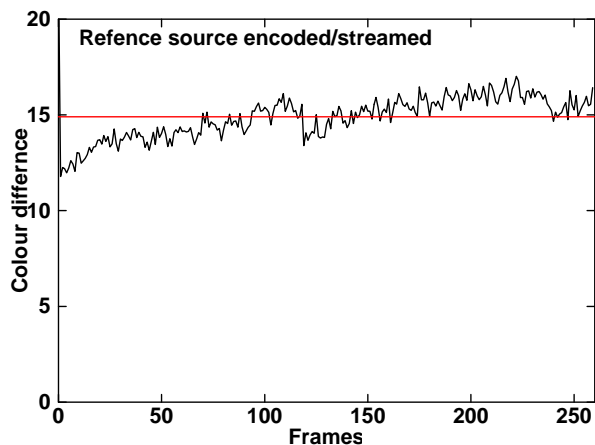

Figure 6c – Example for SRC15_REF__525

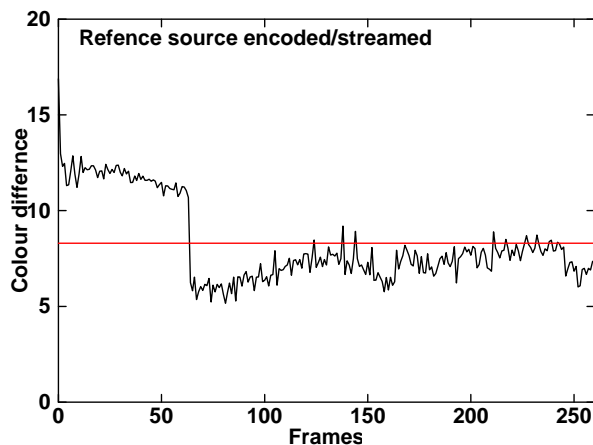

Figure 6d – Example for SRC16_REF__525

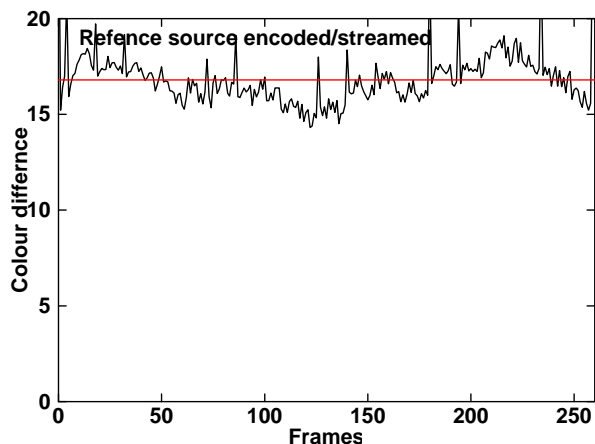

Figure 6e – Example for SRC17_REF__525

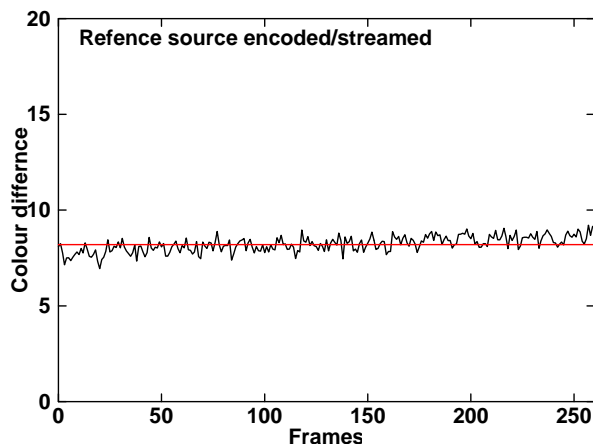

Figure 6f – Example for SRC18_REF__525

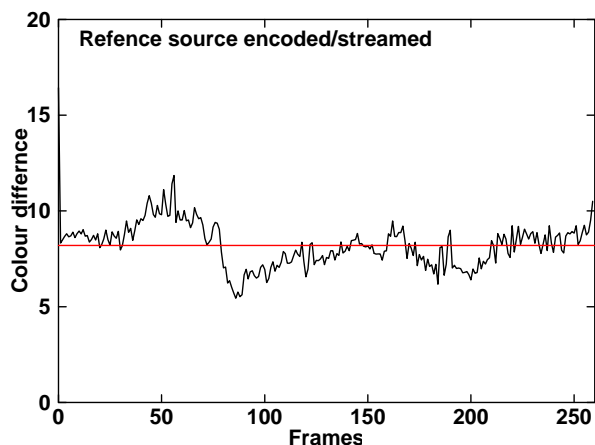

Figure 6g – Example for SRC19_REF__525

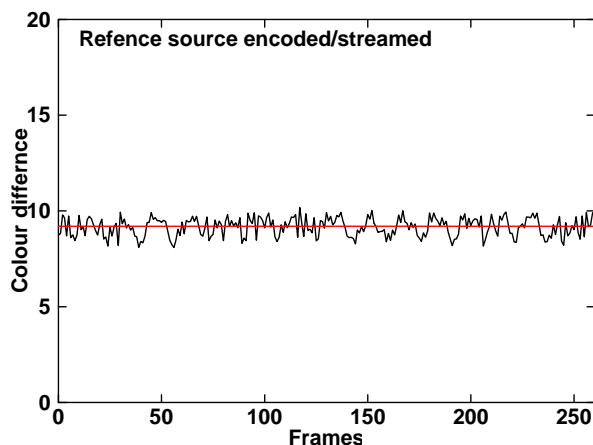

Figure 6h – Example for SRC20_REF__525

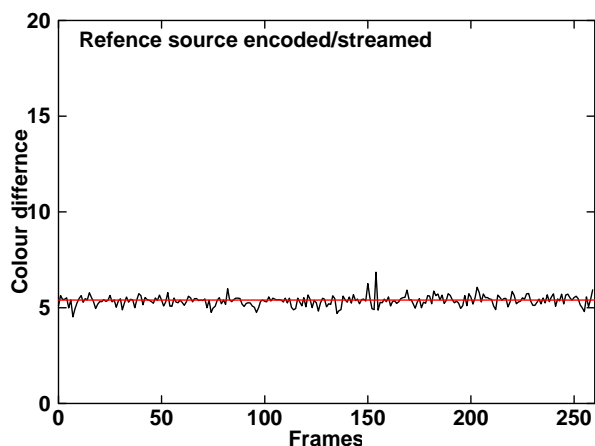

Figure 6i – Example for SRC21_REF__525

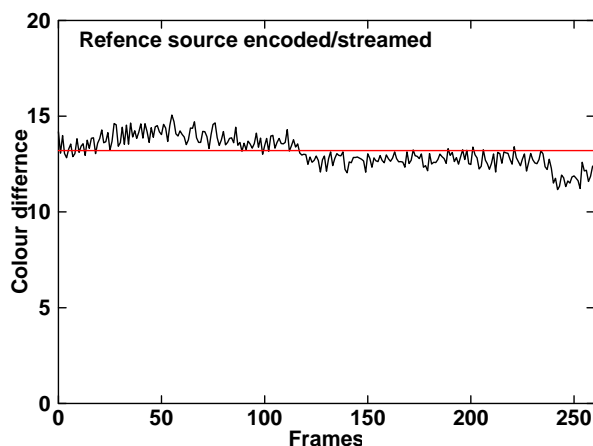

Figure 6j – Example for SRC22_REF__525

Condition of assessment:

- Video frame size: 320 x 240 pixels
- Frame rate: 30 fps
- Streaming bit-rate: 250 kbps
- Network bandwidth: more than 250 kbps
- Reproduction: Microsoft Media Player® version 7.1

Figure 6 – Colour differences between reference and streamed video frames at 250 kbps and 30 fps

As summary of the assessment, acquired data should also be averaged over frames so as to provide the single metric for objective assessment as the grand average as in equation (2). It should be reported as in table 4.

$$\overline{\Delta E_{ab}^*} = \frac{1}{(K_2 - K_1 + 1)} \sum_{k=K_1}^{K_2} \overline{\Delta E_{ab_k}^*} \quad (2)$$

Table 4 – Grand averages of colour differences

Reference video source	Grand average of colour difference
SRC13_REF__525	9,6
SRC14_REF__525	8,4
SRC15_REF__525	14,9
SRC16_REF__525	8,3
SRC17_REF__525	16,8
SRC18_REF__525	8,2
SRC19_REF__525	8,2
SRC20_REF__525	9,2
SRC21_REF__525	5,4
SRC22_REF__525	13,2

5.5 End-to-end objective assessment of video quality in wavelet transformed domain

5.5.1 Item to be assessed

The root mean square errors between corresponding blocks in wavelet transformed domain corresponding to the reference video and the deteriorated video, which has been proposed in ITU-R 6Q/42-E.

Three-level wavelet transform is assumed. Therefore, there are 10 blocks as shown in figure 7 and figure 8 as an example.

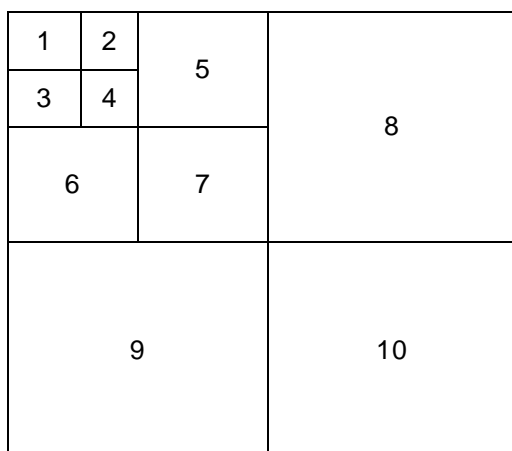

Figure 7 – Assignment of the block numbers

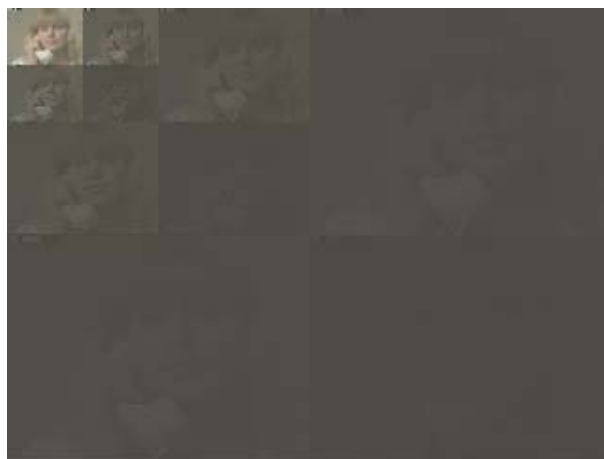

Figure 8 – Example of wavelet decomposition visualised

5.5.2 Method of assessment

Reference videos in table 1 are used as the item 1 of figure 2. Frame size reduced videos in uncompressed AVI-format should be prepared for the item 2 of figure 2. It is necessary to embed frame numbers at this point so that they can be used to identify received frames corresponding to the transmitted frames.

Encoded and transmitted streaming videos shall be continuously captured. Pixel-by-pixel calculations should be conducted.

The root mean square errors between each of corresponding blocks $p=1...10$ to the original video frame and the deteriorated video frame k should be acquired as followings.

Let coefficients in wavelet domain be $c_{R_{o,ijpk}}$, $c_{G_{o,ijpk}}$ and $c_{B_{o,ijpk}}$ for the position (i, j) of the block p of reference red, green, and blue pixel data, respectively; $c_{R_{d,ijpk}}$, $c_{G_{d,ijpk}}$ and $c_{B_{d,ijpk}}$ for the position (i, j) of the block p of deteriorated red, green, and blue pixel data, respectively.

Deterioration d_{pk} at the block p of the frame k in the wavelet domain should be evaluated by the sum square error as in equations (3) and (4).

$$d_{pk} = \sum_i \sum_j \left(\Delta c_{R_{ijpk}}^2 + \Delta c_{G_{ijpk}}^2 + \Delta c_{B_{ijpk}}^2 \right) \quad (3)$$

where

$$\begin{aligned} \Delta c_{R_{ijpk}} &= c_{R_{d,ijpk}} - c_{R_{o,ijpk}} \\ \Delta c_{G_{ijpk}} &= c_{G_{d,ijpk}} - c_{G_{o,ijpk}} \\ \Delta c_{B_{ijpk}} &= c_{B_{d,ijpk}} - c_{B_{o,ijpk}} \end{aligned} \quad (4).$$

5.5.3 Presentation of assessment results

The metric of the sum of square errors between blocks corresponding to the wavelet transformed frames should be plotted versus frame numbers as shown in figure 9 together with identifications of reference video sources. The conditions of measurement such as frame size in pixels, frame rate, streaming bit-rate should also be reported.

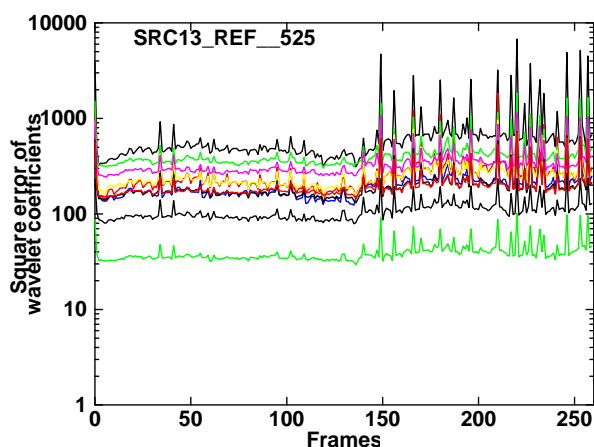

Figure 9a – Example for SRC13_REF_525

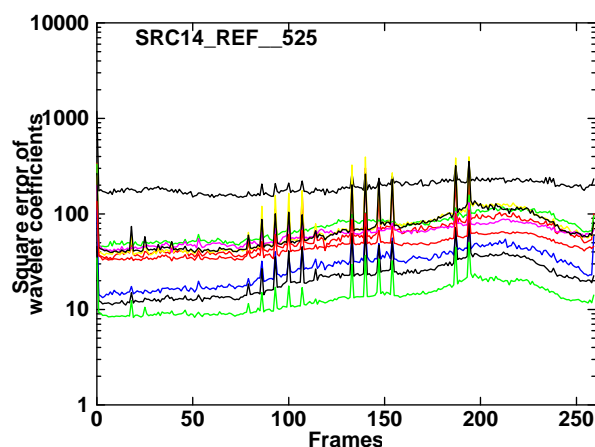

Figure 9b – Example for SRC14_REF_525

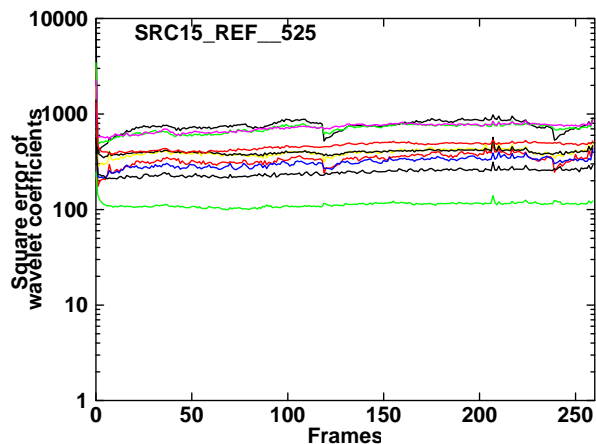

Figure 9c – Example for SRC15_REF_525

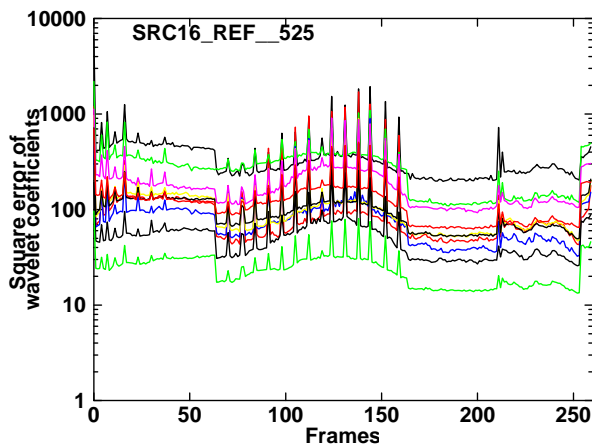

Figure 9d – Example for SRC16_REF_525

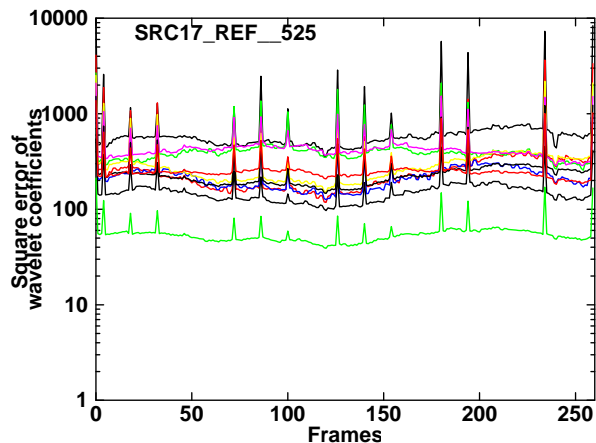

Figure 9e – Example for SRC17_REF_525

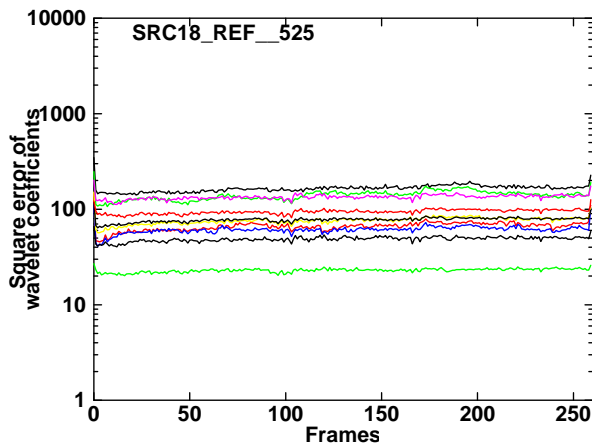

Figure 9f – Example for SRC18_REF_525

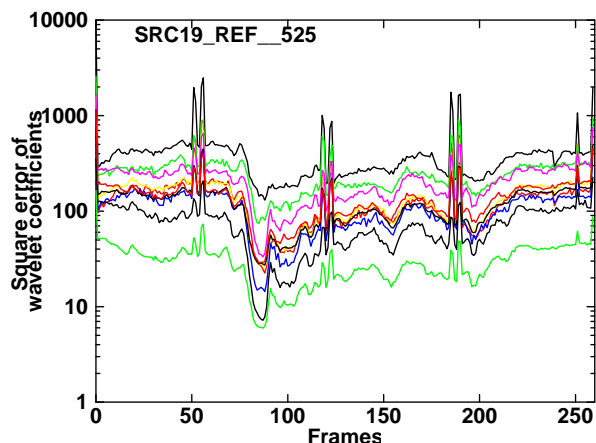

Figure 9g – Example for SRC19_REF_525

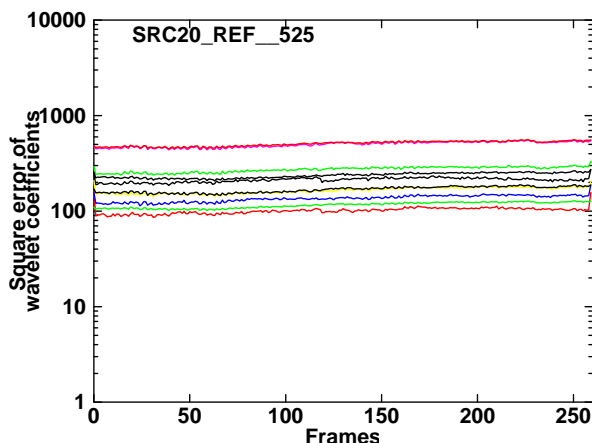

Figure 9h – Example for SRC20_REF_525

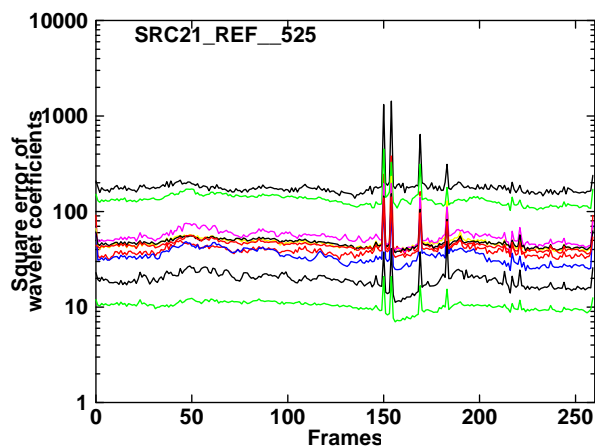

Figure 9i – Example for SRC21_REF_525

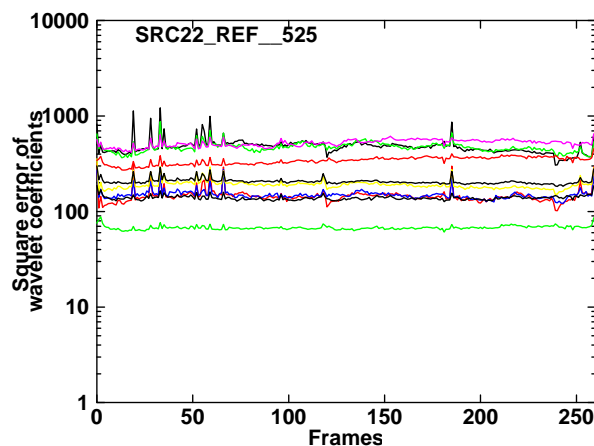

Figure 9j – Example for SRC22_REF_525

Condition of assessment:

- Video frame size: 320 x 240 pixels
- Frame rate: 30 fps
- Streaming bit-rate: 250 kbps
- Network bandwidth: more than 250 kbps
- Reproduction: Microsoft Media Player® version 7.1

Figure 9 – Trends of difference of coefficients of wavelet transform between reference and streamed video frames at 250 kbps and 30 fps

As summary of the assessment, acquired square errors should also be averaged over entire frames as in equation (5) so as to provide the overall metrics for objective assessment. It should be reported as in table 5.

$$\bar{C}_p = \frac{1}{(K_2 - K_1 + 1)} \sum_{k=K_1}^{K_2} d_{kp} \quad (5)$$

In order to assess the video quality rating (VQR) as a single metric for each of the received videos, a weighted sum VQR of the metrics in table 5 calculated as in equation (6) should be reported at the rightmost column of table 5.

$$VQR = w_0 + \sum_{p=1}^{10} w_p \bar{C}_p \quad (6)$$

where w_0 is a offset and w_p , $p=1...10$ are the weights for VQR to be best correlated to the DMOS for a set of the reference videos, studied by former ITU-R 10-11Q and ITU-R WP 6Q (see ITU-R 10-11Q/54-E).

Table 5 – Summary of difference of coefficients of wavelet coefficients

Reference video source	$\overline{C_1}$	$\overline{C_2}$	$\overline{C_3}$	$\overline{C_4}$	$\overline{C_5}$	$\overline{C_6}$	$\overline{C_7}$	$\overline{C_8}$	$\overline{C_9}$	$\overline{C_{10}}$	VQR
SRC13_REF__525	725	300	440	212	275	343	109	201	203	40	20,4
SRC14_REF__525	197	64	76	30	77	62	23	74	47	14	14,7
SRC15_REF__525	785	346	714	314	401	728	245	404	464	112	43,3
SRC16_REF__525	388	120	289	94	117	191	53	105	125	25	17,1
SRC17_REF__525	733	309	438	241	317	443	153	247	262	56	28,2
SRC18_REF__525	165	67	140	61	77	134	49	78	95	23	18,7
SRC19_REF__525	441	150	266	113	152	217	74	128	140	30	19,9
SRC20_REF__525	212	101	273	136	165	500	168	237	510	116	35,1
SRC21_REF__525	187	42	136	35	49	56	20	48	45	10	14,3
SRC22_REF__525	483	147	472	150	191	522	139	207	342	68	29,7

Note – The values of the VQR's depend directly on a set of weights to be applied. The example at the rightmost column is provisional based on a set of weights prepared in Chiba University in January 2002.

5.6 End-to-end objective assessment of video quality using the Peak-signal to noise ratio (PSNR)

5.6.1 Item to be assessed

Peak-signal to noise power ratios, PSNR's, in three-dimensional coordinate systems.

5.6.2 Method of assessment

Reference videos in table 1 are used as the item 1 of figure 2. Frame size reduced videos in uncompressed AVI-format should be prepared for the item 2 of figure 2. It is necessary to embed frame numbers at this point so that they can be used to identify received frames corresponding to the transmitted frames.

Encoded and transmitted streaming videos shall be continuously captured. Pixel-by-pixel calculation should be conducted.

The peak-signal to noise ratio (PSNR) between a full reference image and a reproduced image recommended in ITU-T J.144 should be used. It defined the PSNR by the following equation (7).

$$PSNR = 10 \log_{10} \left(\frac{S_{\max}^2}{MSE} \right) \quad (7)$$

$$MSE = \frac{1}{K} \sum_{p=P1}^{P2} \sum_{m=M1}^{M2} \sum_{n=N1}^{N2} (d(p,m,n) - o(p,m,n))^2$$

where $K = \frac{1}{(P2 - P1 + 1)(M2 - M1 + 1)(N2 - N1 + 1)}$; $d(p,m,n)$ and $o(p,m,n)$ represent, respectively, degraded and original pixel vectors at frame p , row m and column n , and S_{\max} is the maximum possible value of the pixel vectors.

For colour images, each picture element is normally composed of three dimensional values, red (R), green (G) and blue (B). Thus, the definition in equation (8) applies for the mean-square errors.

$$MSE_{RGB} = \frac{1}{K} \sum_{p=P_1}^{P_2} \sum_{m=M_1}^{M_2} \sum_{n=N_1}^{N_2} \left((R_d - R_o)^2 + (G_d - G_o)^2 + (B_d - B_o)^2 \right) \quad (8)$$

where $S_{\max(RGB)} = 3 \times 2^{2(N-1)}$ for the values in N -bit encoding.

It is recommended to evaluate the PSNR in the more uniform colour space, CIE 1976 LAB, as in equation (9).

$$MSE_{Lab} = \frac{1}{K} \sum_{p=P_1}^{P_2} \sum_{m=M_1}^{M_2} \sum_{n=N_1}^{N_2} \left((L_d^* - L_o^*)^2 + (a_d^* - a_o^*)^2 + (b_d^* - b_o^*)^2 \right) \quad (9)$$

where $S_{\max(Lab)} = \sqrt{(L_{\max}^*)^2 + (a_{\max}^*)^2 + (b_{\max}^*)^2}$, actual value of which depends on a colour gamut of original RGB colour space. It is recommended to use the default RGB colour space defined by IEC 61966-2-1, in which $S_{\max(Lab)} = 148,254$.

NOTE – It should be noted that the terms for summation in equation (8) are the square of the colour differences in the psychophysically uniform colour space described in 5.4.

Additionally, luminance signal Y and two colour difference signals C_b and C_r denoted as Y_{cc} will also be calculated for comparison as in equation (10).

$$MSE_{Ycc} = \frac{1}{K} \sum_{p=P_1}^{P_2} \sum_{m=M_1}^{M_2} \sum_{n=N_1}^{N_2} \left((Y_d - Y_o)^2 + (C_{b_d} - C_{b_o})^2 + (C_{r_d} - C_{r_o})^2 \right) \quad (10)$$

where $S_{\max(Ycc)} = 1,01659$ in YCbCr system defined in IEC 61966-2-1 Amendment 1.

5.6.3 Presentation of assessment results

The PSNR's in three-dimensional spaces Lab, Ycc and RGB together with one-dimensional PSNR's in L^* and Y should be reported as shown in figure 10.

The conditions of measurement such as frame size in pixels, frame rate, streaming bit-rate should also be reported.

NOTE – In order to demonstrate software developed by Chiba University in collaboration with Mitsubishi Electric Corp. for various quality metrics regarding the known hypothetical deterioration used in the Video Quality Expert Group (VQEG) in terms of three-dimensional PSNR's and one-dimensional PSNR's together with the average colour difference are attached in Annex A for information.

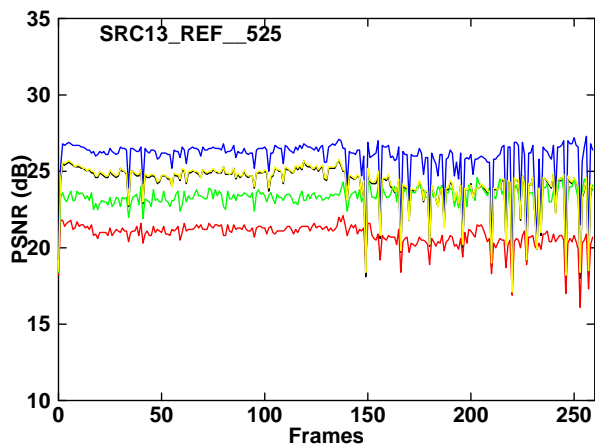

Figure 10a – SRC13_REF_525

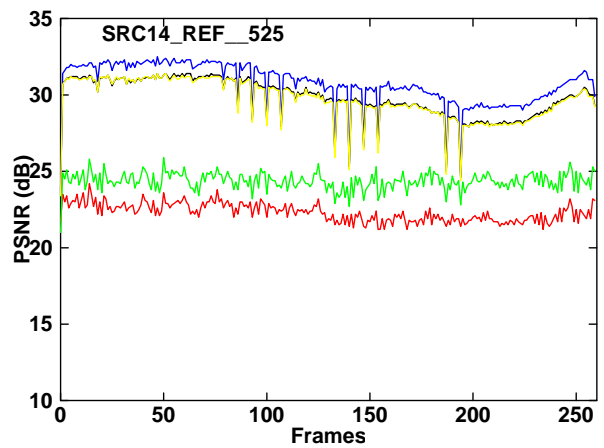

Figure 10b – SRC14_REF_525

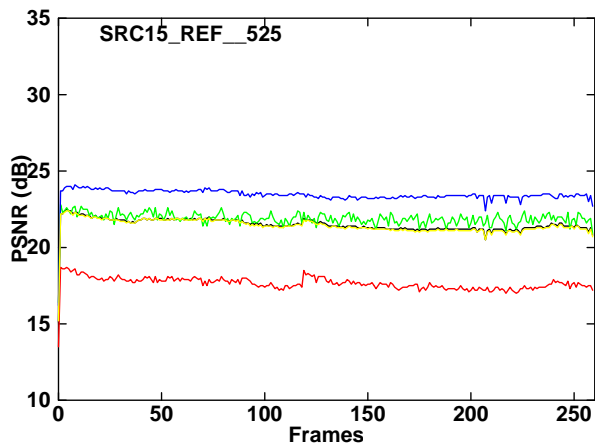

Figure 10c – SRC15_REF_525

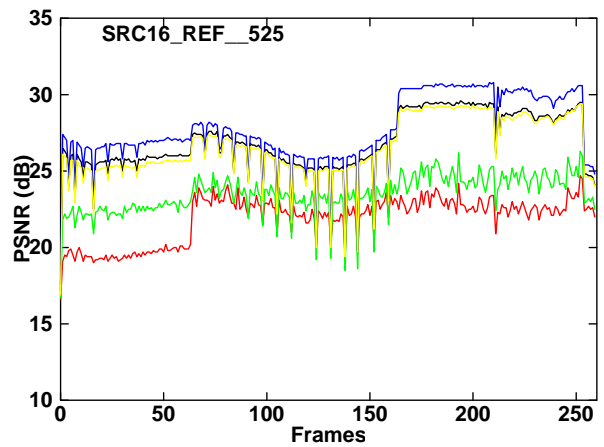

Figure 10d – SRC16_REF_525

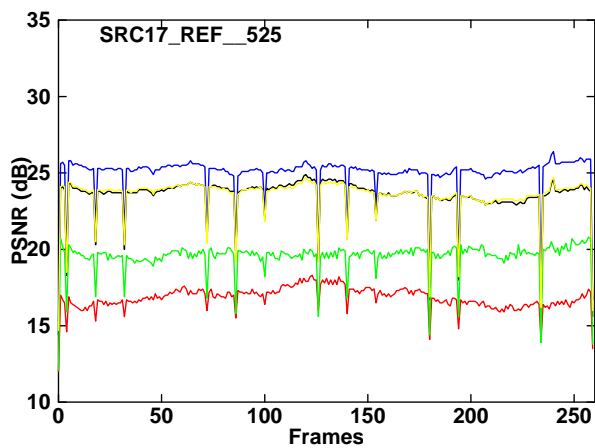

Figure 10e – SRC17_REF_525

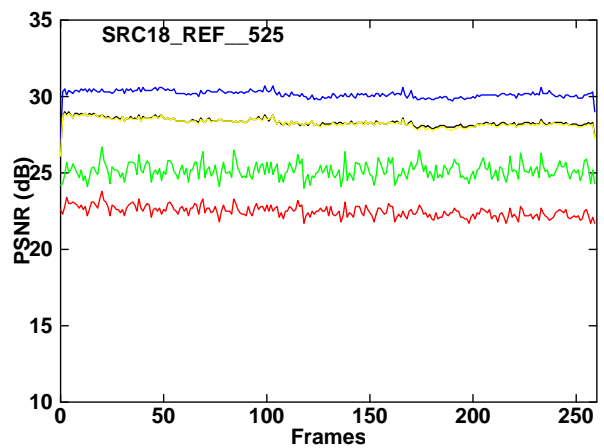

Figure 10f – SRC18_REF_525

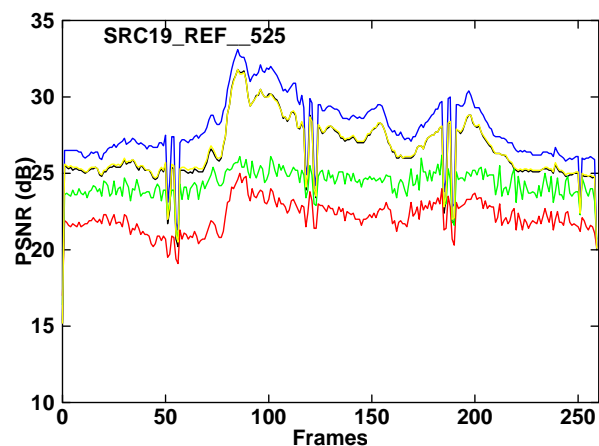

Figure 10g – SRC19_REF_525

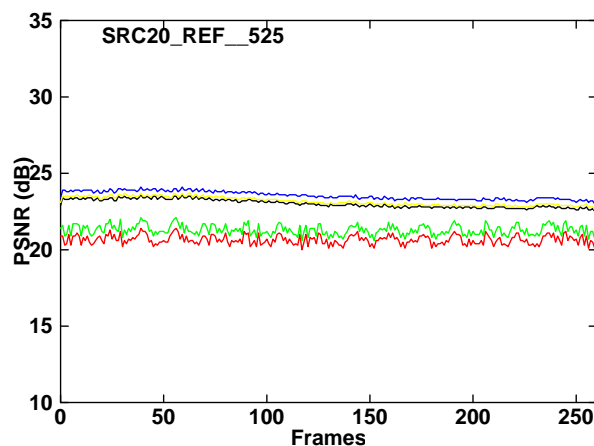

Figure 10h – SRC20_REF_525

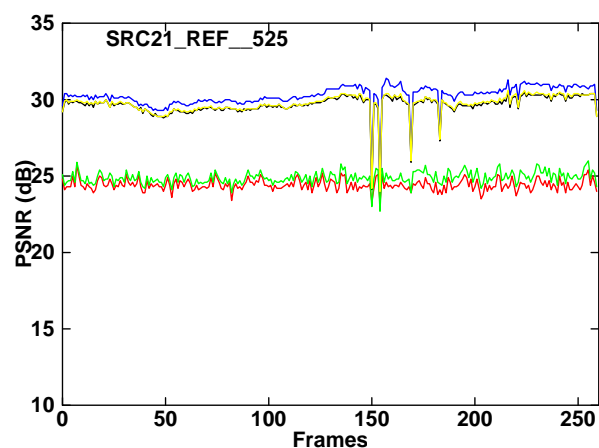

Figure 10i – SRC21_REF_525

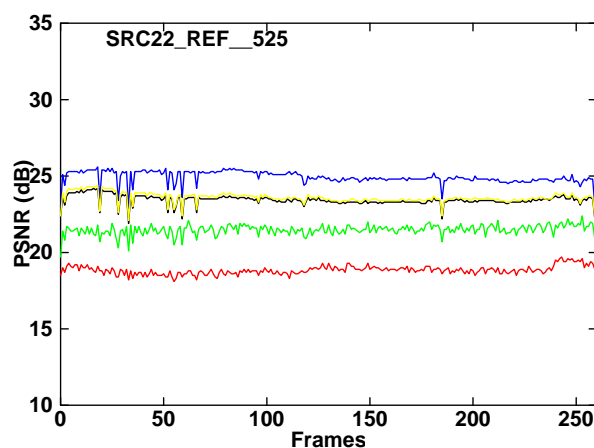

Figure 10j – SRC22_REF_525

Condition of assessment:

- Video frame size: 320 x 240 pixels
- Frame rate: 30 fps
- Streaming bit-rate: 250 kbps
- Network bandwidth: more than 250 kbps
- Reproduction: Microsoft Media Player® version 7.1

Figure 10 – Examples of PSNR assessment

As summary of the assessment, the PSNR's should also be averaged over frames so as to provide the overall metrics for objective assessment as in equation (11). It should be reported as in table 6.

$$\overline{PSNR} = \frac{1}{(K_2 - K_1 + 1)} \sum_{k=K_1}^{K_2} PSNR_k \quad (11)$$

Table 6 – Overall PNSR's averaged over the frames

Reference identification	RSNR in CIELAB	RSNR in YCC	RSNR in RGB	RSNR in L*	RSNR in Y
SRC13_REF_525	20,9	24,4	24,4	23,3	26,1
SRC14_REF_525	22,3	29,9	30,0	24,4	30,9
SRC15_REF_525	17,7	21,5	21,5	21,9	23,5
SRC16_REF_525	22,1	27,0	27,2	23,7	28,2
SRC17_REF_525	16,9	23,7	23,7	19,6	25,1
SRC18_REF_525	22,5	28,3	28,3	25,2	30,2
SRC19_REF_525	22,3	27,0	27,0	24,4	28,4
SRC20_REF_525	20,7	23,2	23,0	21,3	23,6
SRC21_REF_525	24,4	29,8	29,7	24,9	30,3
SRC22_REF_525	18,8	23,6	23,5	21,5	24,9

6 Audio quality

6.1 Perceived audio quality with full-reference signals

6.1.1 Item to be assessed

Perceived evaluation of audio quality (PEAQ) recommended by ITU-R BS.1387.

6.1.2 Justification

Perceived audio quality (PEAQ) is one of the key factors when designing digital audio-video communication systems. Formal listening tests have been the relevant method for judging audio quality. However, subjective quality assessments are both time consuming and expensive. It was desirable to develop an objective measurement method in order to produce an estimate of the audio quality. Traditional objective measurement methods, like signal-to-noise-ratio (SNR) or total-harmonic-distortion (THD) have never really been shown to relate reliably to the perceived audio quality. The problems become even more evident when the methods are applied modern codecs, which are both non-linear and non-stationary. After thorough verification, ITU-R recommends an objective measurement method, known as PEAQ (Perceived Evaluation of Audio Quality), to estimate the perceived audio quality of equipment under test, for example a low bit-rate codec. This method is specified in ITU-R BS.1387 and described briefly in Annex B.

The output variable from the PEAQ objective measurement method is the objective difference grade (ODG) and distortion index (DI). The ODG corresponds to the subjective difference grade (SDG) in the subjective domain. The resolution of the ODG is limited to one decimal. One should however be cautious and not generally expect that a difference between any pair of ODGs of a tenth of a grade is significant. The DI has the same meaning as the ODG. However, DI and ODG can only be compared quantitatively but not qualitatively. As a general rule, the ODG should be used as the quality measure for ODG values greater than approximately $-3,6$. The ODG correlates very well with subjective assessment in this range. When ODG value is less than $-3,6$, the DI should be used. Therefore, both ODG or DI variables shall be measured.

6.1.3 Method of assessment and algorithm of PEAQ

The basic concept for PEAQ objective measurement method is illustrated in figure 11. It consists of two inputs, one for the (unprocessed) reference audio signal, corresponding to the item 2 of figure 2, and the other for the audio signal under the test. The latter may, for example, be the output signal of digital audio-video communication systems, corresponding to the output of the item 4 in figure 2, that is stimulated by the reference signal.

This measurement method is applicable to most types of audio signal processing equipment, both digital and analogue. It is, however, applied by focusing on digital audio communication channels in this document. The block "device under test" corresponds to the items 2 and 3 in figure 2.

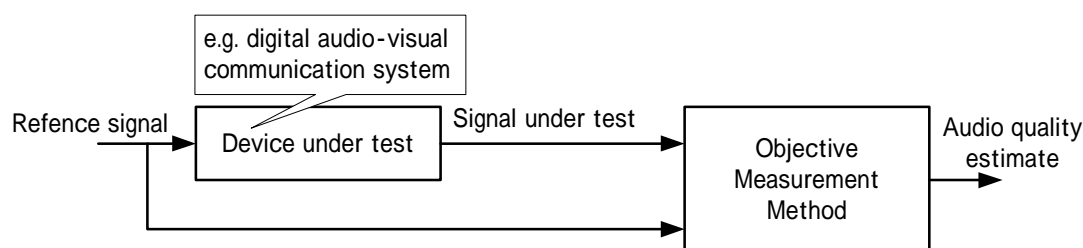

Figure 11 – Basic concept for making objective measurements

A representation of PEAQ model is shown in figure 12. The PEAQ method is based on generally accepted psychoacoustic principles. In general, it compares a signal that has been processed in some way with the corresponding time-aligned reference signal. In the first step of signal processing, the peripheral ear is modelled as known as “perceptual model”, or “ear model.” Concurrent frames of the reference and the processed signals are each transformed to the outputs of ear models. In a consecutive step, algorithm models the audible distortion present in the signal under test by comparing the outputs of the ear models. The information obtained by these processes results into several values, so called MOVs (model output variables) and may be useful for detailed analysis of the signal.

The final goal is to drive a quality metric, consisting of a single number that indicates the audibility of the distortions present in the signal under test. In order to archive this, some further processing of the MOVs is required which simulates the cognitive part of the human auditory system. Therefore, the PEAQ algorithm incorporates an artificial neural network.

There are two versions of the PEAQ; a “Basic” version, featuring a low complexity approach, and an “Advanced” version for higher accuracy at the trade off of higher complexity. The structure of both versions is very similar, and fits exactly into the PEAQ model shown in figure 9. The major difference between the basic and the advanced version is hidden in the respective ear models and the set of MOVs used. Annex B provides more information about PEAQ, which help readers to understand the measurement results.

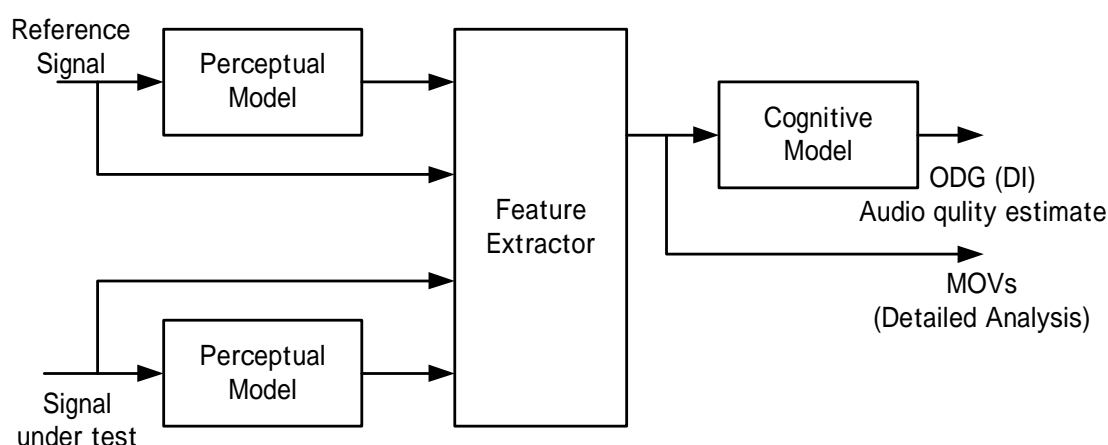

Figure 12 – Representation of PEAQ model

It is recommended to use the reference items available from the ITU as WAV-files (Microsoft RIFF format) on a CD-ROM. All reference items have been sampled at 48 kHz in 16-bit PCM. The reference and test signals provided by the ITU have already been time and level adapted to each other, so that no additional gain or delay compensation is required.

The measurement algorithm must be adjusted to a listening level of 92 dB SPL.

6.1.4 Presentation of assessment results

PEAQ measurement results should be reported in terms of the names of the reference and signal under test items², and the resulting DI and ODG values in a table.

Table 7 is related to the basic version, and table 8 contains the values for the advanced version.

² The names of the corresponding reference items are derived by replacing the substring “cod” in the names of the test items by “ref”, e.g. the reference item for “bcodtri.wav” is “breftri.wav”.

Table 7 – Test items and resulting DI and ODG values for the basic version

Item	DI	ODG	Item	DI	ODG	Item	DI	ODG
Acodsna.wav	1,304	-0,7	Fcodtr2.wav	-0,045	-1,9	lcodhrp.wav	1,041	-0,9
Bcodtri.wav	1,949	-0,3	fcodtr3.wav	-0,715	-2,6	lcodpip.wav	1,973	-0,3
Ccodsax.wav	0,048	-1,8	gcodcla.wav	1,781	-0,4	mcodcla.wav	-0,436	-2,3
Dcodryc.wav	1,648	-0,5	hcodryc.wav	2,291	-0,2	ncodsfe.wav	3,135	0,0
Ecodsmg.wav	1,731	-0,4	Hcodstr.wav	2,403	-0,1	scodclv.wav	1,689	-0,4
Fcodsb1.wav	0,677	-1,2	lcodsna.wav	-3,029	-3,8			
Fcodtr1.wav	1,419	-0,6	kcodsme.wav	3,093	0,0			

Table 8 – Test items and resulting DI and ODG values for the advanced version

Item	DI	ODG	Item	DI	ODG	Item	DI	ODG
Acodsna.wav	1,632	-0,5	Fcodtr2.wav	0,162	-1,7	Lcodhrp.wav	1,538	-0,5
Bcodtri.wav	2,000	-0,3	Fcodtr3.wav	-0,783	-2,7	Lcodpip.wav	2,149	-0,2
Ccodsax.wav	0,567	-1,3	Gcodcla.wav	1,457	-0,6	Mcodcla.wav	0,430	-1,4
Dcodryc.wav	1,725	-0,4	Hcodryc.wav	2,410	-0,1	Ncodsfe.wav	3,163	0,0
Ecodsmg.wav	1,594	-0,5	Hcodstr.wav	2,232	-0,2	Scodclv.wav	1,972	-0,3
Fcodsb1.wav	1,039	-0,9	lcodsna.wav	-2,510	-3,7			
Fcodtr1.wav	1,555	-0,5	Kcodsme.wav	2,765	-0,0			

6.2 Sampling rate and quantization resolution

6.2.1 Item to be assessed

Sampling rate and bandwidth of the reference and the processed audio signals.

6.2.2 Method of assessment

Sampling rate is relevant to the bandwidth of audio signals. For high-quality audio signals, the sampling rates 48 kHz, 44,1 kHz are used. The sampling rate and bandwidth of the reference and processed audio signals should be extracted.

Resolution of quantization relates to the dynamic range of audio signals or quantization noise. For high-quality audio signals, the linear (or uniform) quantization method, which have 16-bit quantization resolution, are used. The resolution and quantization method should be identified.

6.2.3 Presentation of assessment results

Extracted and identified values should be reported.

6.3 Delay

6.3.1 Item to be assessed

Delay time in seconds from audio inputs to an encoder and received digital audio signals.

6.3.2 Method of assessment

Pulsed audio signals should be used as input in terms of the item 2 of figure 2. Lap time between the input of the item 3 and the output of the item 4 in figure 2 should be measured in seconds.

NOTE – In most audio communication systems over the digital networks, a buffering scheme is incorporated. Therefore, buffering time is also taken into account in the measurement.

6.3.3 Presentation of assessment result

The measured delay time should be reported in seconds.

7 Total quality

7.1 Synchronization of audio and video (lip sync)

7.1.1 Item to be assessed

Temporal synchronization between audio and video channels.

7.1.2 Method of assessment

The raison d'être of true multimedia systems, in contrast to a mere collection of unrelated media channels, is the ability to keep temporal synchronization among different channels. It is therefore vitally important to include a temporal synchronization quality measurement in the quality assessment items of audio-video communication systems.

The framework for measurement of temporal synchronization among media channels is given in ITU-T Recommendation P.931. Its basic assumption is that media signal can be captured at such interfaces as the camera output and the display input for the visual channel and the microphone output and the loudspeaker input for the audio channel. This assumption is shown in figure 1.

Media signals at those interfaces are digitised, if necessary, broken into fixed sized frames, and given timestamps. For the details for this procedure, refer to ITU-T Recommendation P.931.

The audio and the video media streams being considered, digitized frames of these media streams are given sequence numbers as follows:

- $A(m)$ and $V(n)$ are the input audio and the video frames, respectively (m and n are the sequence numbers for each stream). It is assumed that they are associated in the sense that they correspond to the same event.
- $A'(p)$ and $V'(q)$ are the output audio and the video frames, respectively.
- $T_A(m)$ and $T'_A(n)$ are the timestamps for $A(m)$ and $A'(n)$, respectively. Timestamps for other frames are defined in the same way.

For each input frame, however not all the input frames are to be used as described in ITU-T P.931, the corresponding output frame is to be found. Since the media stream data is modified, distorted, dropped and reshaped, the matching process is non-trivial. For video frames, the method which utilizes the metrics of PSNR's assessed in 5 will be used. For audio frames, a two-stage process, which employs the audio envelopes for a coarse stage and the power spectral densities for a fine stage, will be used. For details, refer to ITU-T P.931.

It is assumed here that the matching relationships between $A(m)$ and $A'(p)$, and $V(n)$ and $V'(q)$ are established. Under this assumption, the time skew between the audio and video frames is given by the following expression (12):

$$S_{AV}(p, q) = O'_{AV}(p, q) - O_{AV}(m, n) \quad (12)$$

where $Q_{AV}(m, n) = T_A(m) - T_V(n)$ and $Q'_{AV}(p, q) = T'_A(p) - T'_V(q)$.

NOTE 1 – It is important to choose appropriate input audio signals to obtain a valid and meaningful assessment result. If the video signal contains still or almost-still scenes, the process for matching the input and the output frames will become difficult or even impossible. A similar caution is to be applied to the assessment of the audio channel.

NOTE 2 – Modern video compression schemes give fluctuating compression, transmission (when variable bit-rate encoding is employed) and decompression times, depending on the input properties. Therefore, the appropriate input signals suited for the assumed application should be used for assessment.

NOTE 3 – For systems with a low video frame rate, it is sometimes natural and desirable to have a larger temporal skew between the video and the audio streams, because the video delay fluctuates while the audio data generally flows isochronously.

Selection of standard audio-video input streams suited for common usage is left for future study.

7.1.3 Presentation of assessment results

The report from the measurement should be expressed such that any variation between individual measurement is clearly illustrated. Classical summary statistics (for example, minimum, maximum, average and standard deviation) may also be reported.

7.2 Scalability

7.2.1 Item to be assessed

Autonomous function to tune frame rate dynamically depending on available bandwidth between the sender and the receiver.

7.2.2 Method of assessment

The method for measurement of scalability is left for future study.

7.2.3 Presentation of assessment results

Under consideration.

7.3 Overall quality

7.3.1 Item to be assessed

Overall quality factor in terms of audio and video interaction.

7.3.2 Method of assessment

Overall quality of audio-video communication systems OQ_{AV} should be defined as in equation (13).

$$OQ_{AV} = aQ_V + bQ_A + cQ_{V\&A} \quad (13)$$

where Q_V is the objective quality metric assessed in clause 5, Q_A is the objective quality metric assessed in clause 6, $Q_{V\&A}$ is the objective quality metric assessed in this clause; the

coefficients a , b and c are the weighting factors, which depend on actual applications of the audio-video communication system.

7.3.3 Presentation of assessment results

The overall quality factor should be reported with sufficient information on the audio-video communication system under assessment.

Annex A (informative)

PSNR's defined in three-dimensional spaces applied to hypothetical deterioration over the reference video sources

A.1 Introduction

This informative annex is intended to demonstrate the definitions PSNR's in three-dimensional vector space for each of pixel that consists of a frame of videos. The definition for PSNR in the CIELAB is given in equation (8), PSNR in sYCC in equation (9), PSNR in sRGB in equation (7). The average colour difference defined in equation (1) is also included in this annex for comparison together with one-dimensional PSNR's in L^* and Y .

The values of the objective quality measures will be easily compared with other possible future measures and the results of subjective assessment of video quality.

A.2 Test sources and hypothetical deterioration

In this annex, known 16 different hypothetical deterioration over the digital video files in prepared in ITU-R BT.601-5 format and used in the Video Quality Expert Group (VQEG). The source videos are labelled from SRC13_REF__525.yuv to SRC22_REF__525.yuv. They are made use of by the permission of the VQEG.

Software for varieties of objective measures have been developed in Chiba University, Japan, in collaboration with Mitsubishi Electric Corp. The values have been obtained for reduced frame size of 320 x 240 pixels per frame over 260 frames. In other words, $P1=1$, $P2=260$, $M1=1$, $M2=240$ and $N1=1$, $N2=320$ in equation (6). Numerical results are shown in tables A.1 to A.5.

Table A.1 – PSNR's in various colour spaces and the colour difference for SRC13 and SRC14

	Lab	sYCC	sRGB	L*	Y	ΔE		Lab	SYCC	sRGB	L*	Y	ΔE
hrc1/src13	20.5	23.2	23.6	26.3	26.3	8.3	hrc1/src14	22.4	25.8	25.9	26.6	28.1	7.5
hrc2/src13	23.6	23.5	23.2	25.9	25.0	5.4	hrc2/src14	25.7	24.3	24.5	25.4	24.3	4.9
hrc3/src13	22.2	22.7	22.3	25.6	24.6	5.8	hrc3/src14	24.9	23.8	24.0	25.1	24.1	4.7
hrc4/src13	21.4	22.1	21.7	25.6	24.7	7.4	hrc4/src14	24.6	23.9	24.0	25.4	24.3	5.5
hrc5/src13	20.4	19.3	19.0	21.2	20.3	8.0	hrc5/src14	22.5	19.7	20.0	20.7	19.6	5.9
hrc6/src13	22.2	22.6	22.1	25.9	24.9	6.2	hrc6/src14	24.5	23.6	23.8	25.3	24.1	5.0
hrc7/src13	22.2	21.1	20.7	23.0	22.1	5.9	hrc7/src14	24.5	21.5	21.7	22.5	21.4	4.1
hrc8/src13	21.9	22.3	21.9	25.3	24.5	6.7	hrc8/src14	24.3	23.5	23.7	24.9	24.0	5.3
hrc9/src13	21.6	20.6	20.3	22.8	21.8	6.9	hrc9/src14	24.3	21.4	21.7	22.4	21.4	4.5
hrc10/src13	22.1	20.9	20.6	23.0	22.0	6.3	Hrc10/src14	24.3	21.4	21.6	22.5	21.4	4.4
hrc11/src13	21.7	22.8	22.5	24.5	25.3	6.9	Hrc11/src14	25.5	26.0	26.1	24.6	26.3	4.1
hrc12/src13	22.4	23.6	23.3	24.8	26.0	5.9	Hrc12/src14	26.0	26.2	26.4	24.8	26.4	3.7
hrc13/src13	21.3	20.7	20.6	23.4	22.2	6.8	Hrc13/src14	21.5	20.8	21.7	23.2	21.7	5.4
hrc14/src13	21.2	20.3	20.0	22.7	21.6	7.9	Hrc14/src14	23.9	21.3	21.6	22.4	21.3	5.3
hrc15/src13	21.9	22.1	21.7	25.3	24.4	7.6	Hrc15/src14	25.8	25.8	26.0	27.2	26.3	5.6
hrc16/src13	22.1	22.8	22.3	25.8	25.2	7.0	Hrc16/src14	26.0	26.0	26.2	27.4	26.5	5.3

NOTE 1 – hrc16/src14 and so on correspond to hypothetically degraded video (hrc16) from the reference source video (src14), respectively.

NOTE 2 – All videos are in size of 320 x 240 pixels, each of which has 24-bit colour depth.

Table A.2 – PSNR's in various colour spaces and the colour difference for SRC15 and SRC16

	Lab	sYCC	sRGB	L*	Y	ΔE		Lab	SYCC	sRGB	L*	Y	ΔE
hrc1/src15	11.8	13.6	13.1	20.7	19.5	24.8	hrc1/src16	20.3	21.6	21.8	23.8	25.7	9.5
hrc2/src15	17.0	18.5	18.4	24.2	23.1	10.8	hrc2/src16	27.1	28.1	28.0	31.1	32.0	4.4
hrc3/src15	15.1	16.7	16.5	23.1	21.7	13.2	hrc3/src16	29.2	29.0	28.9	31.0	31.9	2.4
hrc4/src15	13.6	15.0	14.5	23.0	21.2	18.7	hrc4/src16	22.9	23.7	23.6	28.3	28.3	6.0
hrc5/src15	14.6	15.4	15.2	19.8	18.9	15.9	hrc5/src16	21.7	22.0	21.9	24.8	25.5	6.0
hrc6/src15	14.0	15.4	15.0	23.0	21.3	17.3	hrc6/src16	23.5	24.2	24.0	28.7	28.7	5.1
hrc7/src15	16.1	17.0	16.9	21.1	20.3	12.1	hrc7/src16	22.8	22.9	22.8	25.7	26.4	4.4
hrc8/src15	14.0	15.3	15.0	22.6	20.9	17.6	hrc8/src16	23.4	24.2	24.0	28.4	28.5	5.2
hrc9/src15	15.9	16.6	16.5	20.7	19.7	13.1	hrc9/src16	22.8	22.7	22.7	25.5	26.1	4.6
hrc10/src15	16.4	17.3	17.2	22.1	21.0	11.9	hrc10/src16	24.9	25.8	25.4	28.9	30.3	3.8
hrc11/src15	15.8	17.2	17.0	22.9	22.0	12.8	hrc11/src16	25.4	27.5	27.3	27.8	31.6	3.8
hrc12/src15	16.0	17.5	17.3	23.3	22.7	12.0	hrc12/src16	25.7	27.9	27.6	28.0	32.2	3.5
hrc13/src15	15.4	16.2	16.1	21.5	19.7	14.6	hrc13/src16	23.3	23.5	23.6	29.1	29.5	4.3
hrc14/src15	15.6	16.1	16.0	20.6	19.2	14.3	hrc14/src16	22.9	22.6	22.6	25.2	25.4	5.2
hrc15/src15	15.7	16.1	16.0	21.1	19.3	15.4	hrc15/src16	23.7	23.3	23.5	26.0	26.2	5.8
hrc16/src15	15.7	16.3	16.2	21.6	19.9	14.9	hrc16/src16	23.9	23.5	23.7	26.2	26.5	5.6

NOTE 1 – hrc16/src14 and so on correspond to hypothetically degraded video (hrc16) from the reference source video (src14), respectively.

NOTE 2 – All videos are in size of 320 x 240 pixels, each of which has 24-bit colour depth.

Table A.3 – PSNR's in various colour spaces and the colour difference for SRC17 and SRC18

	Lab	sYCC	sRGB	L*	Y	ΔE		Lab	sYCC	sRGB	L*	Y	ΔE
hrc1/src17	15.8	19.2	19.2	20.8	23.3	16.7	hrc1/src18	18.3	21.0	20.7	23.2	25.6	10.2
hrc2/src17	20.2	23.2	23.6	26.6	26.9	9.2	hrc2/src18	22.8	24.8	24.5	28.0	28.7	6.0
hrc3/src17	20.2	23.2	23.3	26.2	27.1	8.3	hrc3/src18	22.4	24.2	23.8	27.7	28.0	6.5
hrc4/src17	18.6	21.2	21.6	25.2	25.0	11.1	hrc4/src18	18.1	20.4	19.7	26.6	26.9	9.9
hrc5/src17	18.0	20.1	20.5	22.7	23.0	11.8	hrc5/src18	18.9	20.1	20.0	21.7	22.6	9.0
hrc6/src17	18.5	20.8	21.1	24.9	24.7	10.0	hrc6/src18	19.3	21.6	21.0	27.2	27.4	8.4
hrc7/src17	19.8	21.8	22.1	24.5	24.9	8.6	hrc7/src18	20.3	21.5	21.5	22.8	23.7	7.2
hrc8/src17	18.1	20.5	20.8	24.3	24.2	10.9	hrc8/src18	19.5	21.7	21.2	26.8	27.2	8.4
hrc9/src17	18.6	20.6	20.9	23.4	23.7	10.3	hrc9/src18	20.4	21.5	21.6	22.8	23.6	7.4
hrc10/src17	19.7	21.9	22.2	24.8	25.2	8.9	hrc10/src18	21.6	23.0	22.8	25.3	26.0	6.5
hrc11/src17	18.1	20.4	20.7	23.2	23.9	10.8	hrc11/src18	21.5	24.4	24.0	26.7	29.8	6.4
hrc12/src17	19.0	21.4	21.8	24.1	25.1	9.3	hrc12/src18	21.7	24.5	24.1	26.7	30.1	6.1
hrc13/src17	16.9	18.6	19.0	22.0	22.0	13.2	hrc13/src18	21.9	24.0	23.6	27.7	27.9	6.9
hrc14/src17	18.2	20.3	20.6	23.4	23.4	11.6	hrc14/src18	21.3	22.8	22.6	25.2	25.7	7.2
hrc15/src17	17.8	20.0	20.4	23.0	23.0	13.4	hrc15/src18	21.6	23.7	23.3	29.0	28.5	7.8
hrc16/src17	18.2	20.7	21.2	23.8	24.0	12.5	hrc16/src18	21.7	23.9	23.4	29.4	29.2	7.4

NOTE 1 – hrc16/src14 and so on correspond to hypothetically degraded video (hrc16) from the reference source video (src14), respectively.

NOTE 2 – All videos are in size of 320 x 240 pixels, each of which has 24-bit colour depth.

Table A.4 – PSNR's in various colour spaces and the colour difference for SRC19 and SRC20

	Lab	sYCC	sRGB	L*	Y	ΔE		Lab	sYCC	sRGB	L*	Y	ΔE
hrc1/src19	20.0	22.6	22.6	23.2	25.6	7.8	hrc1/src20	15.8	17.4	17.2	20.1	20.2	12.7
hrc2/src19	23.6	25.1	24.9	27.9	28.6	4.8	hrc2/src20	20.6	20.8	20.7	23.7	22.1	6.9
hrc3/src19	23.1	24.6	24.4	27.7	28.0	5.8	hrc3/src20	18.7	19.3	19.3	22.6	21.3	8.2
hrc4/src19	20.3	22.5	22.1	26.6	27.1	6.9	hrc4/src20	18.7	19.2	19.0	22.6	21.0	8.8
hrc5/src19	19.8	20.8	20.7	22.5	23.3	7.4	hrc5/src20	18.7	16.2	16.0	18.5	16.6	8.3
hrc6/src19	20.6	22.7	22.3	27.0	27.2	6.6	hrc6/src20	18.8	19.4	19.2	23.1	21.4	8.1
hrc7/src19	21.0	21.7	21.7	22.8	23.5	5.9	hrc7/src20	19.4	17.5	17.3	19.6	18.1	7.2
hrc8/src19	20.7	22.6	22.3	26.6	26.9	6.8	hrc8/src20	18.6	19.2	19.0	22.8	21.2	8.4
hrc9/src19	21.2	23.1	22.7	27.2	27.2	6.2	hrc9/src20	20.0	20.3	20.1	23.5	22.0	6.4
hrc10/src19	20.0	21.3	21.1	24.4	24.7	7.8	Hrc10/src20	20.3	18.8	18.6	21.3	19.5	6.5
hrc11/src19	21.4	23.6	23.3	25.6	27.7	6.3	Hrc11/src20	19.9	21.5	21.4	23.3	23.8	6.6
hrc12/src19	22.4	24.7	24.4	25.9	28.8	5.4	Hrc12/src20	20.3	21.9	21.7	23.4	24.1	6.2
hrc13/src19	20.8	21.8	21.7	24.2	24.3	6.9	Hrc13/src20	19.8	18.8	18.7	21.4	19.8	7.8
hrc14/src19	21.1	22.1	22.0	24.8	25.1	7.1	Hrc14/src20	19.6	18.4	18.2	21.1	19.3	7.6
hrc15/src19	23.3	24.6	24.4	28.8	28.5	5.9	Hrc15/src20	19.5	20.3	20.2	23.5	22.2	8.4
hrc16/src19	23.6	25.1	24.8	29.4	29.4	5.4	Hrc16/src20	19.6	20.4	20.4	23.7	22.4	8.3

NOTE 1 – hrc16/src14 and so on correspond to hypothetically degraded video (hrc16) from the reference source video (src14), respectively.

NOTE 2 – All videos are in size of 320 x 240 pixels, each of which has 24-bit colour depth.

Table A.5 – PSNR's in various colour spaces and the colour difference for SRC21 and SRC22

	Lab	sYCC	sRGB	L*	Y	ΔE		Lab	sYCC	sRGB	L*	Y	ΔE
Hrc1/src21	23.1	25.3	25.8	22.8	25.8	5.9	hrc1/src22	14.6	18.0	17.6	22.3	24.1	16.8
Hrc2/src21	29.3	29.1	29.2	28.5	29.6	3.2	hrc2/src22	18.9	21.7	21.0	26.3	26.5	9.3
Hrc3/src21	29.4	28.8	28.8	28.4	29.3	2.9	hrc3/src22	17.0	19.9	19.3	24.8	24.9	11.0
Hrc4/src21	28.4	27.7	27.9	27.3	28.2	3.5	hrc4/src22	17.4	20.1	19.4	25.4	25.6	11.2
Hrc5/src21	25.7	24.0	24.1	22.8	24.0	3.5	hrc5/src22	17.4	18.9	18.0	21.5	21.9	11.2
Hrc6/src21	29.5	28.3	28.5	27.9	28.6	2.8	hrc6/src22	17.2	20.0	19.3	25.7	25.8	10.8
Hrc7/src21	26.0	24.4	24.5	23.1	24.4	3.0	hrc7/src22	18.0	19.9	19.2	22.8	23.3	9.8
Hrc8/src21	29.1	28.1	28.3	27.5	28.4	3.0	hrc8/src22	17.2	19.9	19.2	25.1	25.2	11.1
Hrc9/src21	30.7	29.4	29.5	28.5	29.6	2.0	hrc9/src22	17.9	20.5	19.8	25.4	25.5	9.7
hrc10/src21	28.5	26.9	27.0	25.8	26.9	2.5	hrc10/src22	18.2	20.3	19.5	23.9	24.2	9.7
hrc11/src21	28.8	30.6	30.7	26.7	31.0	2.4	hrc11/src22	18.0	20.8	20.3	24.4	25.6	10.0
hrc12/src21	28.9	30.8	30.9	26.7	31.2	2.2	hrc12/src22	18.3	21.3	20.7	24.9	26.5	9.3
hrc13/src21	27.4	25.8	25.9	25.0	25.9	3.2	hrc13/src22	16.9	18.9	18.5	22.7	22.6	12.2
hrc14/src21	28.2	26.7	26.8	25.7	26.8	2.9	hrc14/src22	17.8	19.7	19.0	23.2	23.2	11.0
hrc15/src21	30.5	30.4	30.5	30.3	31.1	3.2	hrc15/src22	17.8	20.2	19.8	24.4	23.9	12.0
hrc16/src21	30.6	30.5	30.6	30.4	31.2	3.2	hrc16/src22	18.1	20.8	20.3	25.4	25.1	11.3

NOTE 1 – hrc16/src14 and so on correspond to hypothetically degraded video (hrc16) from the reference source video (src14), respectively.

NOTE 2 – All videos are in size of 320 x 240 pixels, each of which has 24-bit colour depth.

Annex B (informative)

PEAQ objective measurement method outline

B.1 Basic concept of the PEAQ measurement algorithm

The basic concept for PEAQ objective measurement method is illustrated in figure B.1. It consists of two inputs, one for the (unprocessed) reference signal and one for the signal under the test. The latter may for example be the output signal of the codec that is stimulated by the reference signal.

This measurement method is applicable to most types of audio signal processing equipment, both digital and analogue. It is, however, expected that many applications will focus on audio codecs.

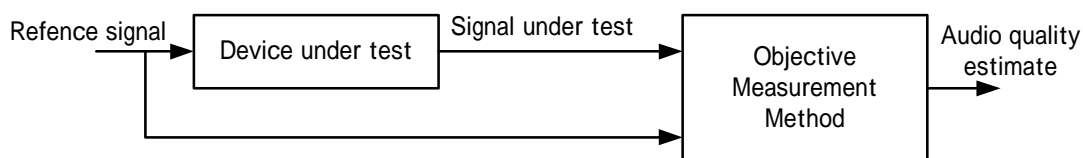

Figure B.1 – Basic concept for making objective measurements

A high-level representation of PEAQ model is shown in figure B.2. PEAQ method is based on generally accepted psychoacoustic principles. In general it compares a signal that has been processed in some way with the corresponding time-aligned reference signal. In the first signal processing step the peripheral ear is modelled (“perceptual model”, or “ear model”). Concurrent frames of the reference and processed signal are each transformed to the outputs of ear models. In a consecutive step, algorithm models the audible distortion present in the signal under test by comparing the outputs of the ear models. The information obtained by these process results into several values, so called MOVs (“Model Output Variables”) and may be useful for detailed analysis of the signal.

The final goal instead is to drive a quality measure, consisting of a single number that indicates the audibility of the distortions present in the signal under test. In order to archive this, some further processing of the MOVs is required which simulates the cognitive part of the human auditory system. Therefore the PEAQ algorithm uses an artificial neural network.

There are two versions of PEAQ, a “Basic” version, featuring a low complexity approach, and an “Advanced” version for higher accuracy at the trade off of higher complexity. The structure of both versions is very similar, and fits exactly into the PEAQ model shown in figure.B.2. The major differences between the “Basic” and the “Advanced” version are hidden in the respective ear models and the set of MOVs used. The “Basic” and “Advanced” versions are described in B.2 and B.3

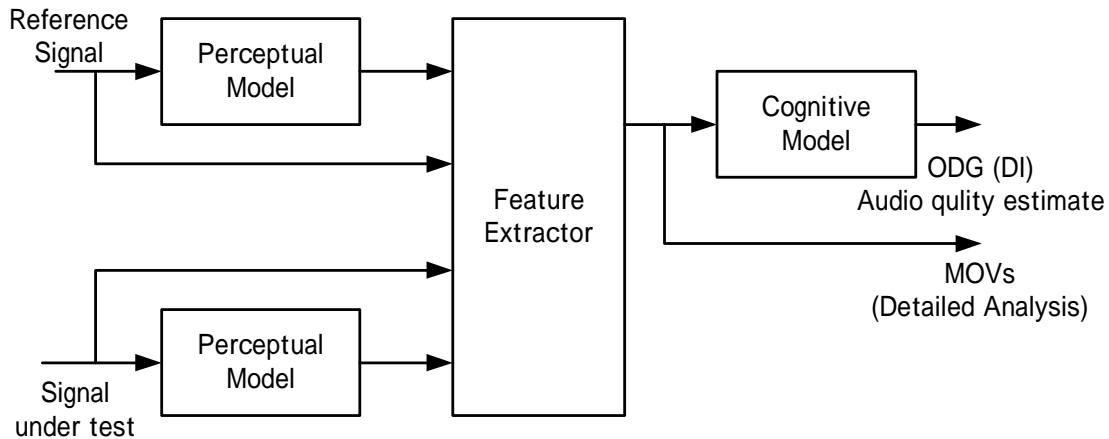

Figure B.2 – Representation of PEAQ model

B.2 Basic version

The “Basic” version implements an FFT based ear model, as outlined in figure B.3.

Most features of this model are based on the fundamental psychoacoustic principles. Figure B.3 shows the signal flow from the input signal to the final calculation of the excitation pattern. The processing starts by a transformation of the input signal to the frequency domain. A 2048-point FFT is applied along with subsequent scaling of the spectra, according to the listening level, which has to be input by the user as a parameter. This results in the frequency resolution of approximately 23,4 Hz, and a corresponding temporal resolution of 23,4 ms (at 48 kHz sampling rate).

In the constructive block, the effects of the outer and middle ear are modelled by weighting the spectrum with the appropriate filter functions. Afterwards the spectra are grouped into critical bands, archiving a resolution of 1/4 bark per band. The subsequent adding of “internal noise” is intended to model effects, such as the permanent masking of sounds in our auditory system caused by the streaming of blood and other physiological phenomena. This step is followed by calculation of masking effects. Simultaneous masking is modelled by a frequency and level dependent spreading function. Temporal masking is modelled only partly since the temporal resolution is the same range as the timing of any background masking effects, which therefore cannot be modelled. Nevertheless, experiments have shown that backward masking is very coarsely modelled by side effects of the FFT.

Using the feature extractor, eleven MOVs are extracted from the compensation of the ear model output. Table B.1 shows a list of those MOVs and their interpretation. For further information about the MOVs please refer to the annex of the ITU-R recommendation BS.1387.

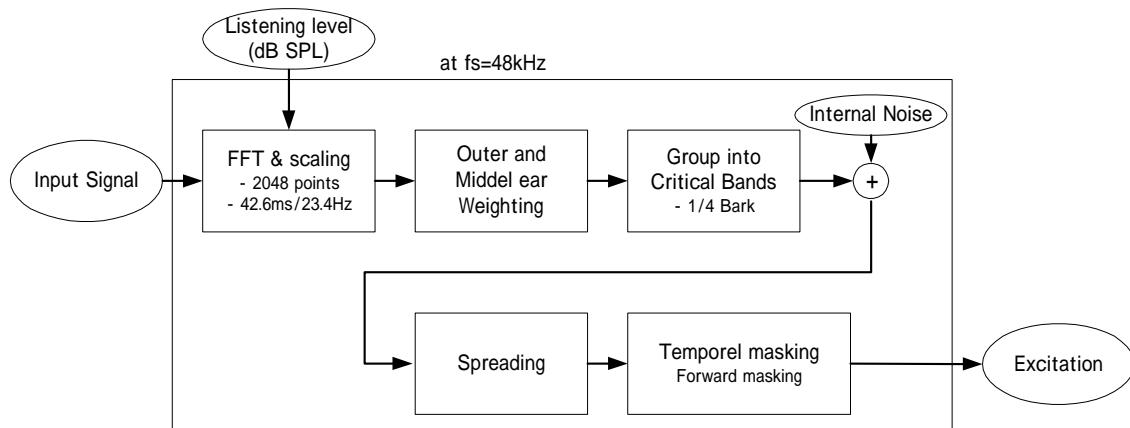

Figure B.3 – FFT based ear model, PEAQ basic version

Table B.1 – Model output variables, PEAQ basic version

Model Output Variable (MOV)	purpose
WinModDiff1 _B	Changes in modulation (related to roughness)
AvgModDiff1 _B	
AvgModDiff2 _B	
RmsNoiseLoud _B	Loudness of the distortion
BandwidthRef _B	Linear distortions (frequency response etc.)
BandwidthTest _B	
RelDistFrames _B	Frequency of audible distortions
Total NMR _B	Noise-to-mask ratio
MFPD _B	Detection probability
ADB _B	
EHS _B	Harmonic structure of the error

B.3 Advanced version

The “Advanced” version use some MOVs derived by implementing the ear model of the “Basic” version but in addition to that it introduces a second ear model with improved temporal resolution, as illustrated in figure B.4.

Compared to the “Basic” version, this model performs the time frequency warping using a filter bank, thus grouping the signal into 40 auditory bands with a temporal resolution of approximately 0,66 ms. This allows for a very accurate modelling of backward masking effects. After the calculation of backward and simultaneous masking, the signal is sub-sampled by a factor of 1:6 in order to improve the computational efficiency. After adding the internal noise to the sub-sampled signal and finally modelling the forward masking effects, the output of this model is again the excitation.

In comparison to the FFT based “Basic” approach, the temporal resolution is improved, thus allowing for better simulation of temporal effects, at the cost of frequency resolution and computational complexity.

Due to the combination of parameters derived from both of the ear models, the number of MOVs used by the “Advanced” version to derive the final quality measure could be reduced to five, while simultaneously the accuracy of the algorithm was slightly improved compared to the “Basic” version. The MOVs used by the “Advanced” version are listed in table 5.2. For more detailed information about the advanced version, see the annex of the ITU-R recommendation BS.1387.

**Figure B.4 – Filter bank based ear model, PEAQ advanced version**

Table B.2 – Model output variables, PEAQ advanced version

Model Output Variable (MOV)	Purpose
RmsNoiseLoudAsym _A	Loudness of the distortion
RmsModDiff _A	Changes in modulation (related to roughness)
AvgLinDist _A	Linear distortions (frequency response etc.)
Segmental NMR _B	Noise-to-mask ratio
EHS _B	Harmonic structure of the error

B.4 Output value of PEAQ method

The Objective Difference Grade (ODG) is the output value of PEAQ method that corresponds to the Subjective Difference Grade (SDG) in the subjective domain. The resolution of the ODG is limited to one decimal. However, one should be cautious and not generally expect that a difference between any pair of ODGs of tenth of a grade is significant. The same remark is valid when looking at results from a subjective listening test. The ODG can also assume positive values. Such values can occur because PEAQ use the cognitive model to map the MOVs to the results of subjective listening test. In the case of subjective listening tests, the SDG can assume a positive value, when a test person has incorrectly assigned the reference and test signal.

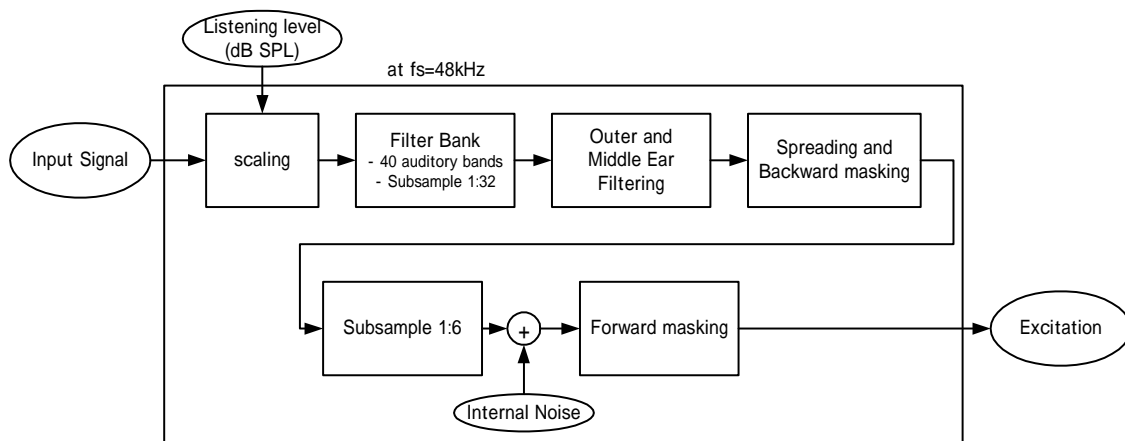
The Distortion Index (DI) has the same meaning as the ODG. However, DI and ODG can only be compared quantitatively but not qualitatively. The DI is characterized by a saturation that is less than the saturation of the ODG value. Furthermore, the range of values is different. As a general rule, you should use the ODG as the quality measure for ODG values greater than approximately $-3,6$. The ODG correlate very well with subjective assessment in this range. When ODG value is less than $-3,6$ you should use the DI.

B.5 Performance of PEAQ measurement method

In order to validate the performance of PEAQ model, a number of different criteria may be relevant. The correlation between ODG and SDG is an obvious criterion to evaluate. In addition two further criteria that consider the reliability of the mean value were used for validation – the Absolute Error Score (AES) and the Tolerance Scheme.

The validation tests performed by ITU-R showed that PEAQ predicts the perceived quality with high-accuracy and is superior to previously existing measurements method. For further information please refer to the annex of the ITU-R recommendation BS.1387 and [AES-PEAQ]¹.

¹ T. Theide et.al. "PEAQ – The ITU standard for Objective Measurement of Perceived Audio Quality," J. Audio Eng. Soc., vol.48, pp 3-29 (2000 Jan./Feb.)

Bibliography

- Recommendation ITU-T P.930 (08/96), Principles of a reference impairment system for video.
- Recommendation ITU-T G.113 (02/01), Transmission impairments due to speech processing, Annex I: Provisional planning values for the equipment impairment factor.
- Recommendation ITU-T P.861 (02/89), Objective quality measurement of telephone-band (300-3400 Hz) speech codecs.
- T. Theide et.al. “PEAQ – The ITU standard for Objective Measurement of Perceived Audio Quality,” J. Audio Eng. Soc., vol.48, pp 3-29 (2000 Jan./Feb.)
- Measuring quality in videoconferencing systems, Part number PC316, Intel Corporation (November 1997)
- Criteria for product evaluation, NASA Desktop video expert center, National Aeronautics and Space Administration, Ames Research Center, Moffett Field, California (August 1997)
- Quality aspects of computer-based video services, Norbert Gerfelder (Fraunhofer Institute for Computer Graphics, Darmstadt, Germany and Wolfgang Muller (Darmstadt Technical University), (Oct. 1995)
- Comparative study on narrow-bandwidth presentation of streaming educational videos, H. Ikeda, S. Dickerson, Y. Higaki, Journal of Faculty of Engineering, Chiba University, Vol. 49, No. 1, pp.19-26 (1997-9).
- ITU-R 10-11Q/56-E: 2001-01, Canada (on behalf of the Entire VQEG body) – Draft Video Quality Experts Group’s Results
- ITU-R 6Q/39-E: 2001-08, Liaison Rapporteur with U.S. Committee T1A1, Documentation of objective video quality metrics
- ITU-R 6Q/42-E: 2001-09, Republic of Korea – Proposed Preliminary Draft New Recommendation – A new method for objective measurement of video quality using wavelet transform